

1366015COM

Mantel with Fireplace



Date of Purchase ___ / ___ / ___
Lot Number:

B341366015COM01GO

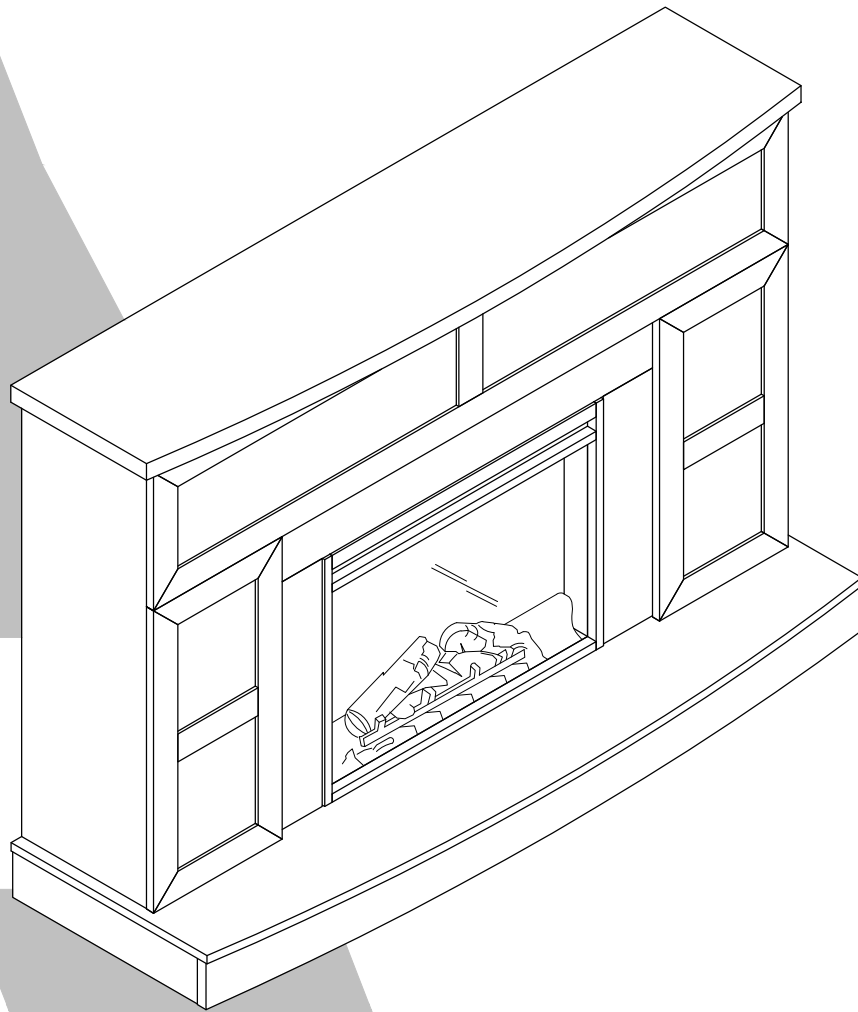

THIS INSTRUCTION BOOKLET CONTAINS **IMPORTANT** SAFETY INFORMATION. PLEASE READ AND KEEP FOR FUTURE REFERENCE.

Do Not Return This Product!

Contact our customer service team for help first.

Call: 1-800-489-3351 (toll free)

Monday-Friday 9am - 5pm CST

Visit: www.ameriwoodhome.com

WARNING

- Unit can tip over causing severe injury or death.
- Anchor unit to stud in wall (if instructed to).
- Do Not allow children to climb on unit.
- Put heavy items on lower shelves or drawers.



Follow Ameriwood Home



Contact Us!

Do NOT return this product!

Contact our friendly customer service team first for help.

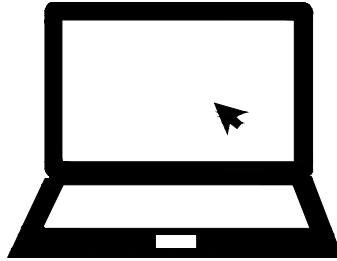
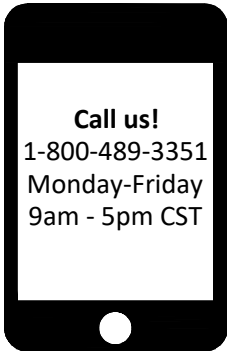

Visit ameriwoodhome.com

Assembly Tips



Helpful Hints

PEOPLE NEEDED FOR ASSEMBLY: 2

ESTIMATED ASSEMBLY TIME: 1.5 HOUR

- Open your item in the area you plan to keep it to avoid excessive heavy lifting.
- Identify, sort and count the parts before attempting assembly.
- Compression dowels are lightly tapped in with a hammer.
- Slides are labeled with a **R** (right) and **L** (left) for proper placement.
- Make sure to always face the point on the top of the Cam Lock towards the outer edge.
- Use all the nails provided for the back panel and spread them out equally.
- Back panel must be used to make sure your unit is sturdy.
- Do NOT use harsh chemicals or abrasive cleaners on this item.
- Never push, pull, or drag your furniture.

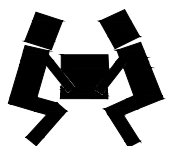
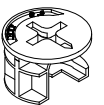
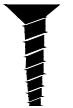

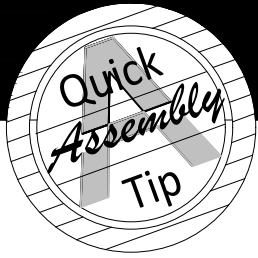

Before You Start

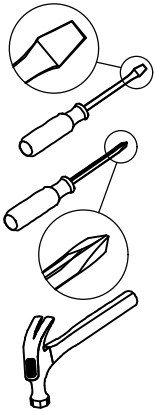

- ✓ Read through each step carefully and follow the proper order
- ✓ Separate and count all your parts and hardware
- ✓ Give yourself enough room for the assembly process
- ✓ Have the following tools: Flat Head Screwdriver, #2 Phillips Head Screwdriver and Hammer
- ✓ Caution: If using a power drill or power screwdriver for screwing, please be aware to slow down and stop when screw is tight. Failure to do so may result in stripping the screw.

Cam Lock Fastening System

This Cam Lock Fastening System will be used throughout the assembly process.

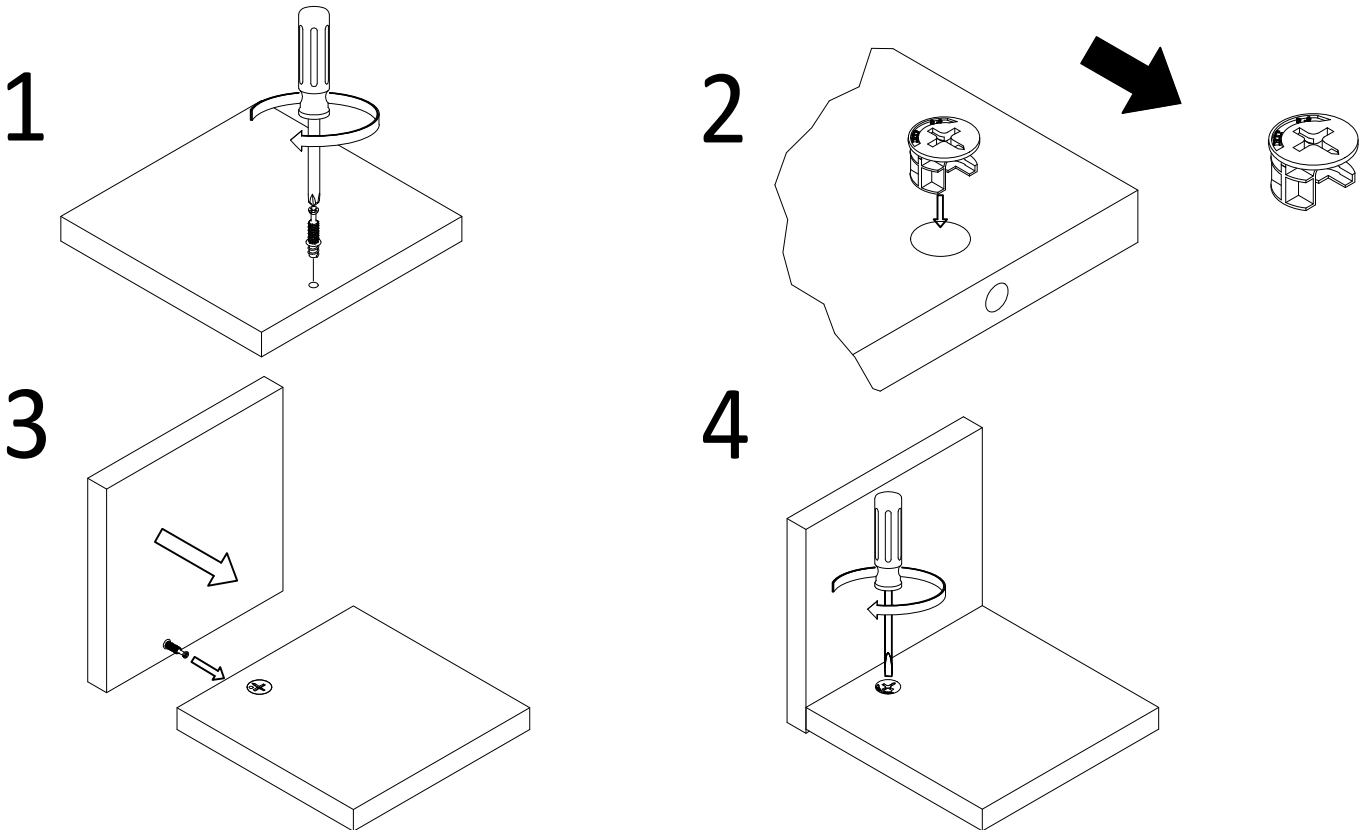

Board Identification

Not actual size

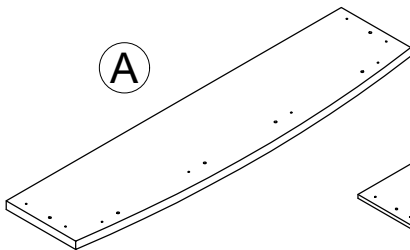

A
Top
T1366015010GO
QTY: 1 PC

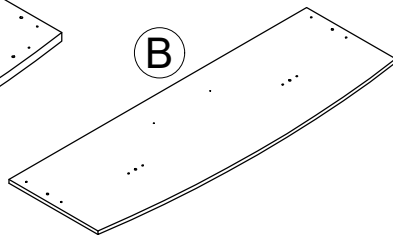

B
Bottom
T1366015020GO
QTY: 1 PC

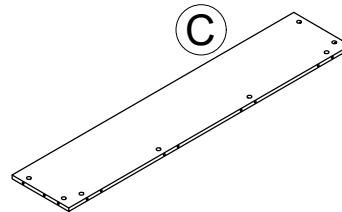

C
Shelf
T1366015030GO
QTY: 1 PC

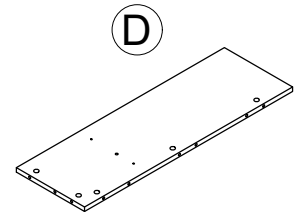

D
Left side
T1366015040GO
QTY: 1 PC

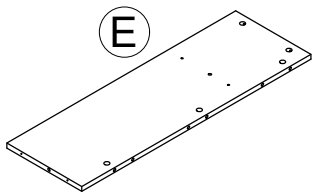

E
Right side
T1366015050GO
QTY: 1 PC

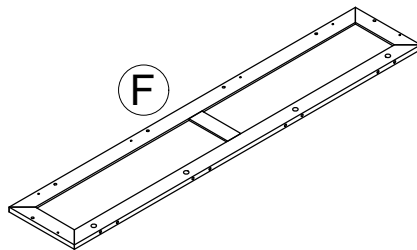

F
Frame upper
T1366015060GO
QTY: 1 PC

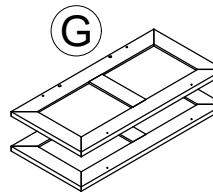

G
Frame lower
T1366015070GO
QTY: 2 PCS

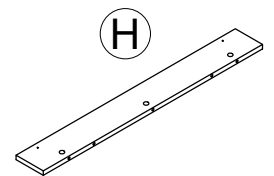

H
Front panel
T1366015080GO
QTY: 1 PC

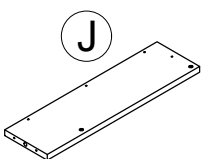

J
Front left panel
T1366015090GO
QTY: 1 PC

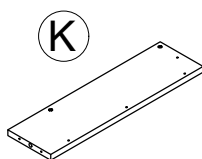

K
Front right panel
T1366015100GO
QTY: 1 PC

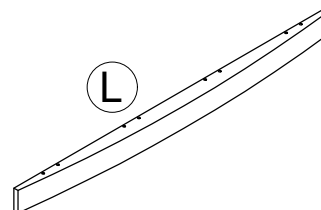

L
Kick panel
T1366015110GO
QTY: 1 PC

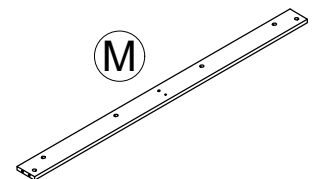

M
Rear support
T1366015120GO
QTY: 1 PC

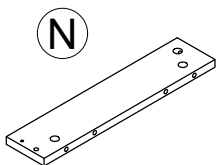

N
Left base panel
T1366015130GO
QTY: 1 PC

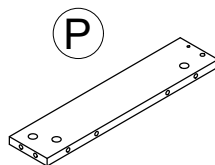

P
Right base panel
T1366015140GO
QTY: 1 PC

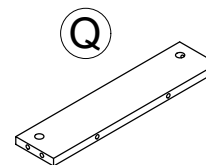

Q
Center base panel
T1366015150GO
QTY: 1 PC

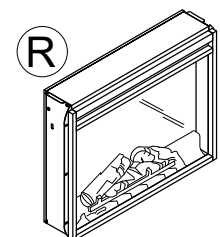

R
Fireplace
FA23V60L-1
QTY: 1PC

Board Identification

Not actual size

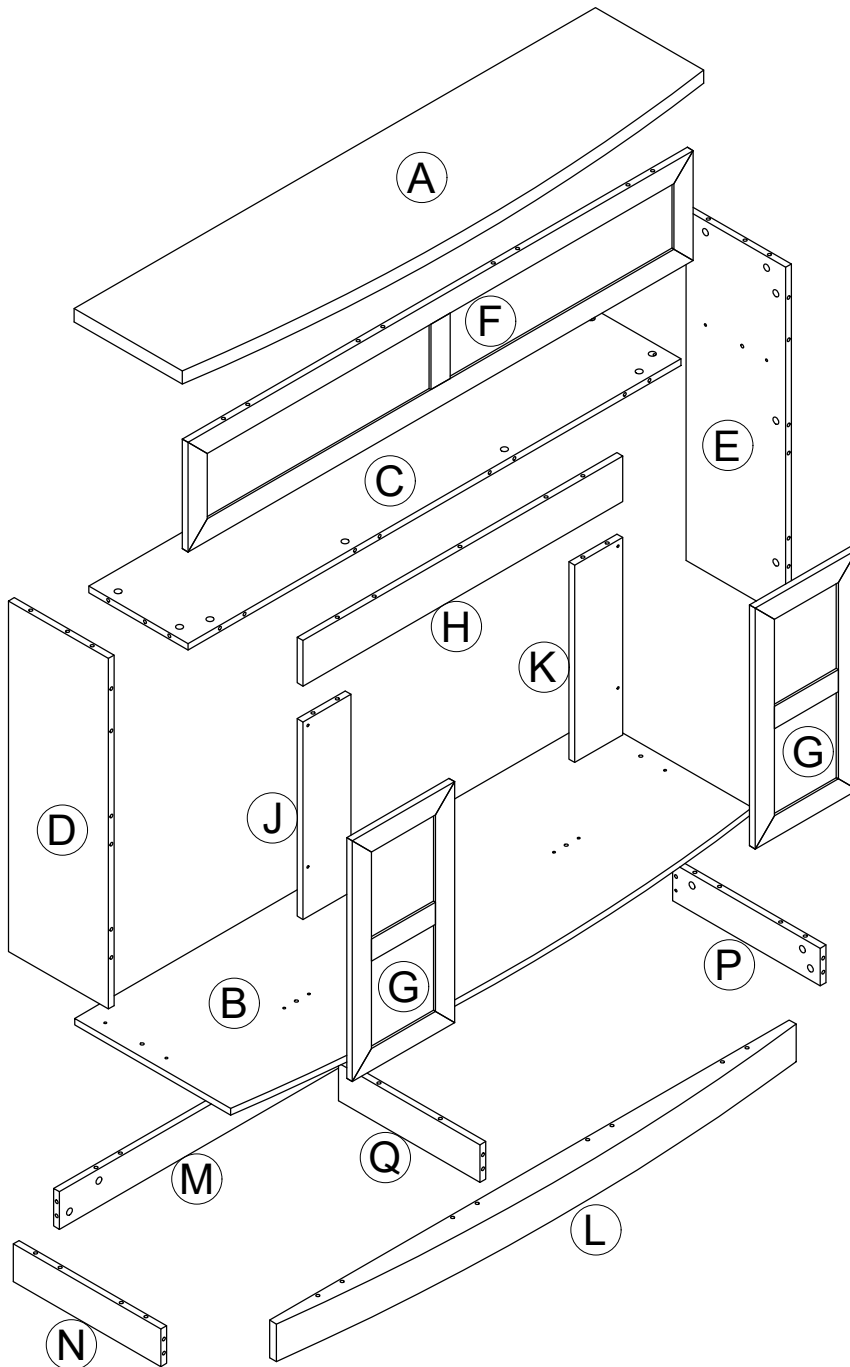

Part List

Actual Size

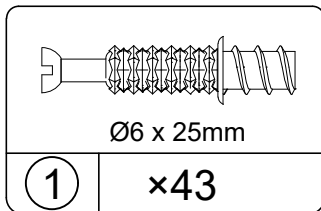

CAM BOLT
TGO2001

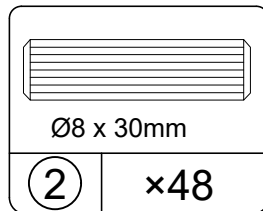

WOOD DOWEL
TGO2900

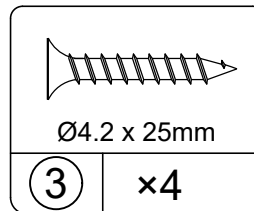

SCREW
TGO1001W

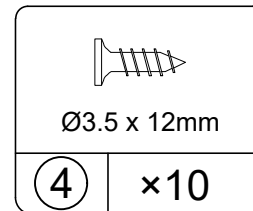

SCREW
TGO1007W

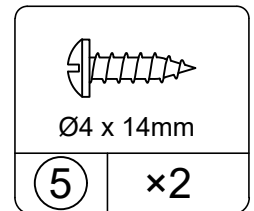

SCREW
TGO1324

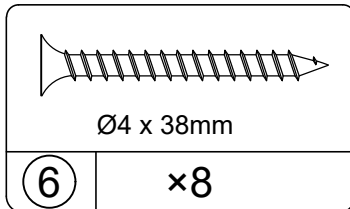

SCREW
TGO1319W

Not Actual Size

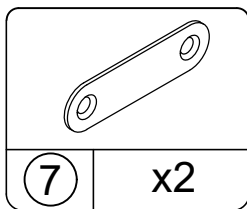

STRIKE PLATE
TGO3526

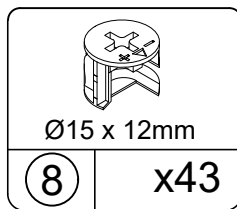

CAM LOCK
TGO2101
Spare: 2 pcs

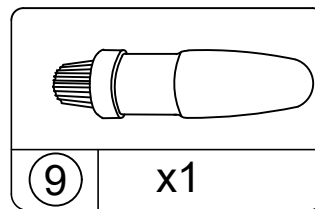

Glue
TGO9001

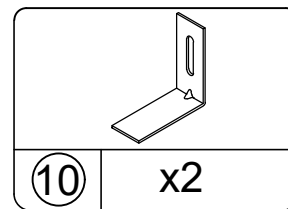

ANGLE BRACKET
TGO3539

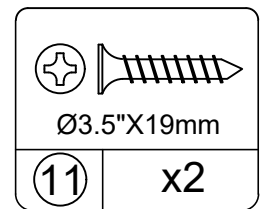

SCREW
TGO1023

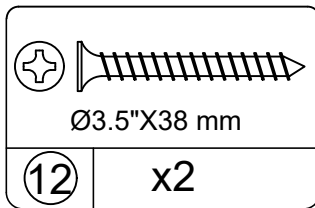

SCREW
TGO1024

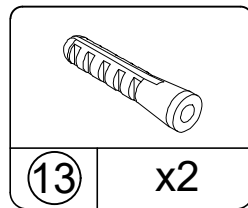

WALL ANCHOR
TGO6502

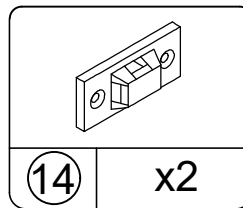

CLIP
TGO6516

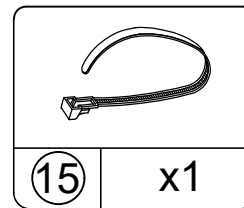

STRAP
TGO6515

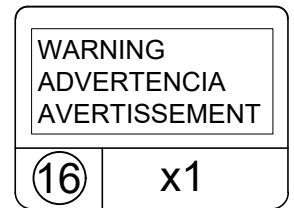

WARNING LABEL
TGO6593

STEP 1

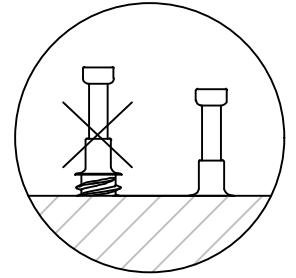
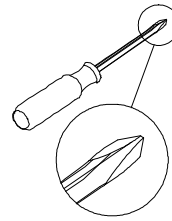
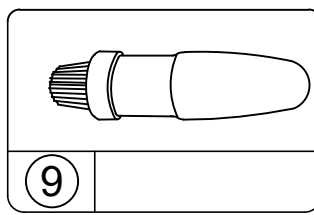
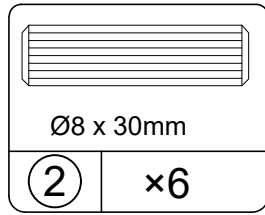
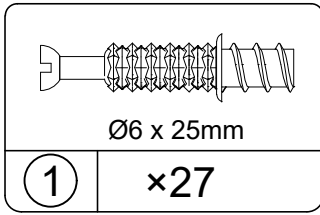

- 1.1 Attach (1) into (A), (B), (C), and (G) as illustrated.
- 1.2 Insert (2) into (C) as illustrated.

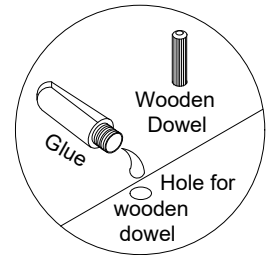

Use one drop of glue in dowel hole.

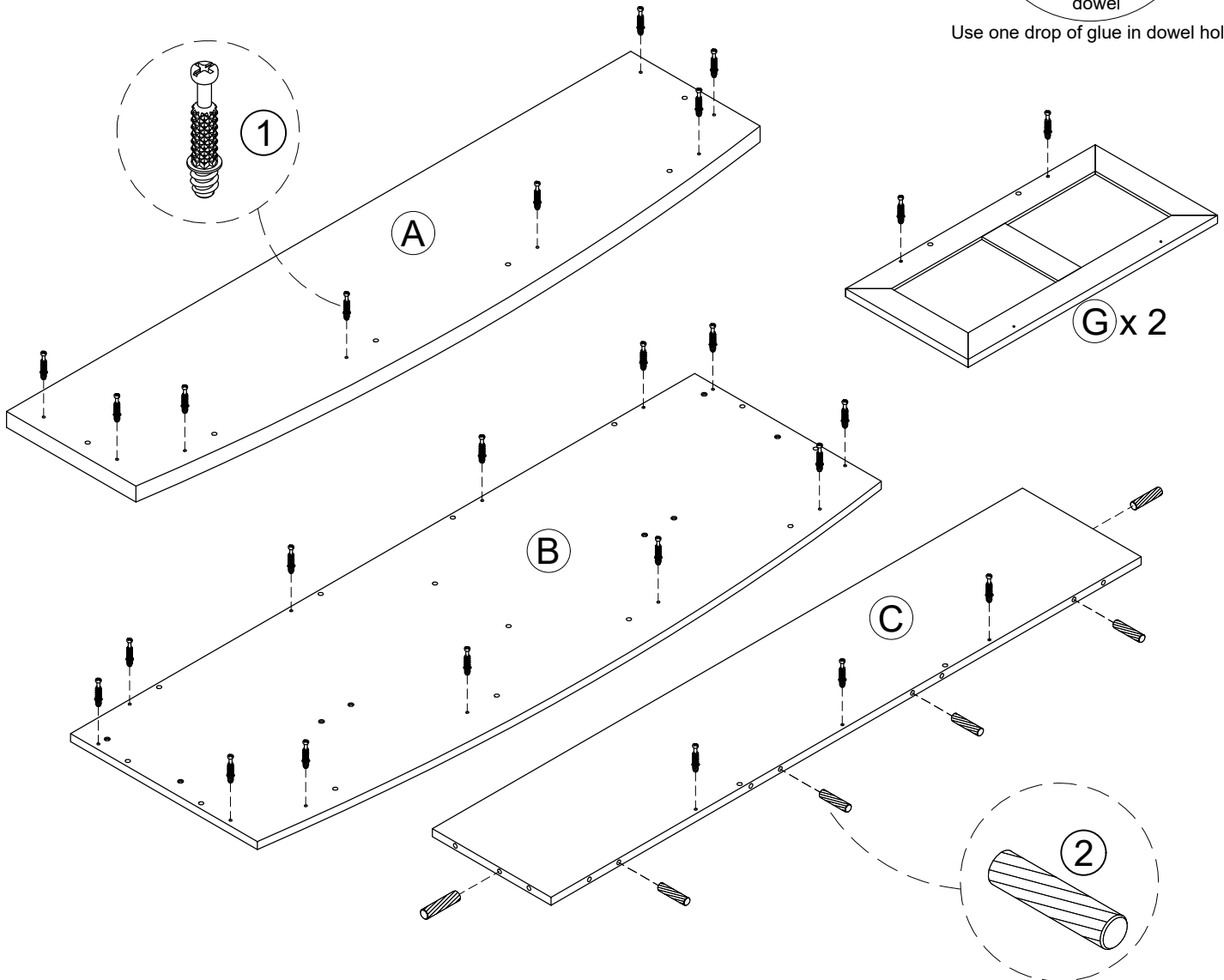

STEP 2

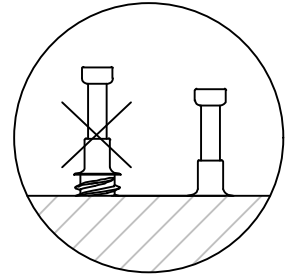
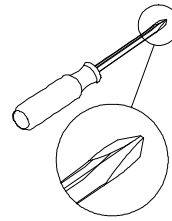
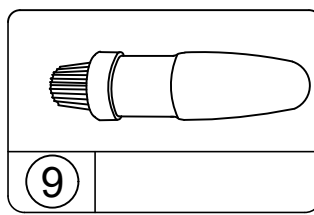
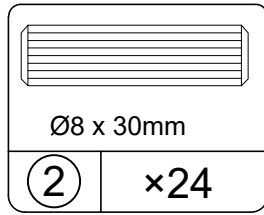
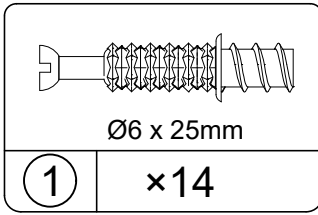

2.1 Attach (1) into (D), (E), (F), (L) and (M) as illustrated.

2.2 Insert (2) into (D), (E), (F), (L) and (M) as illustrated.

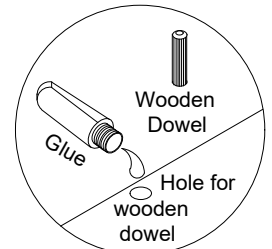
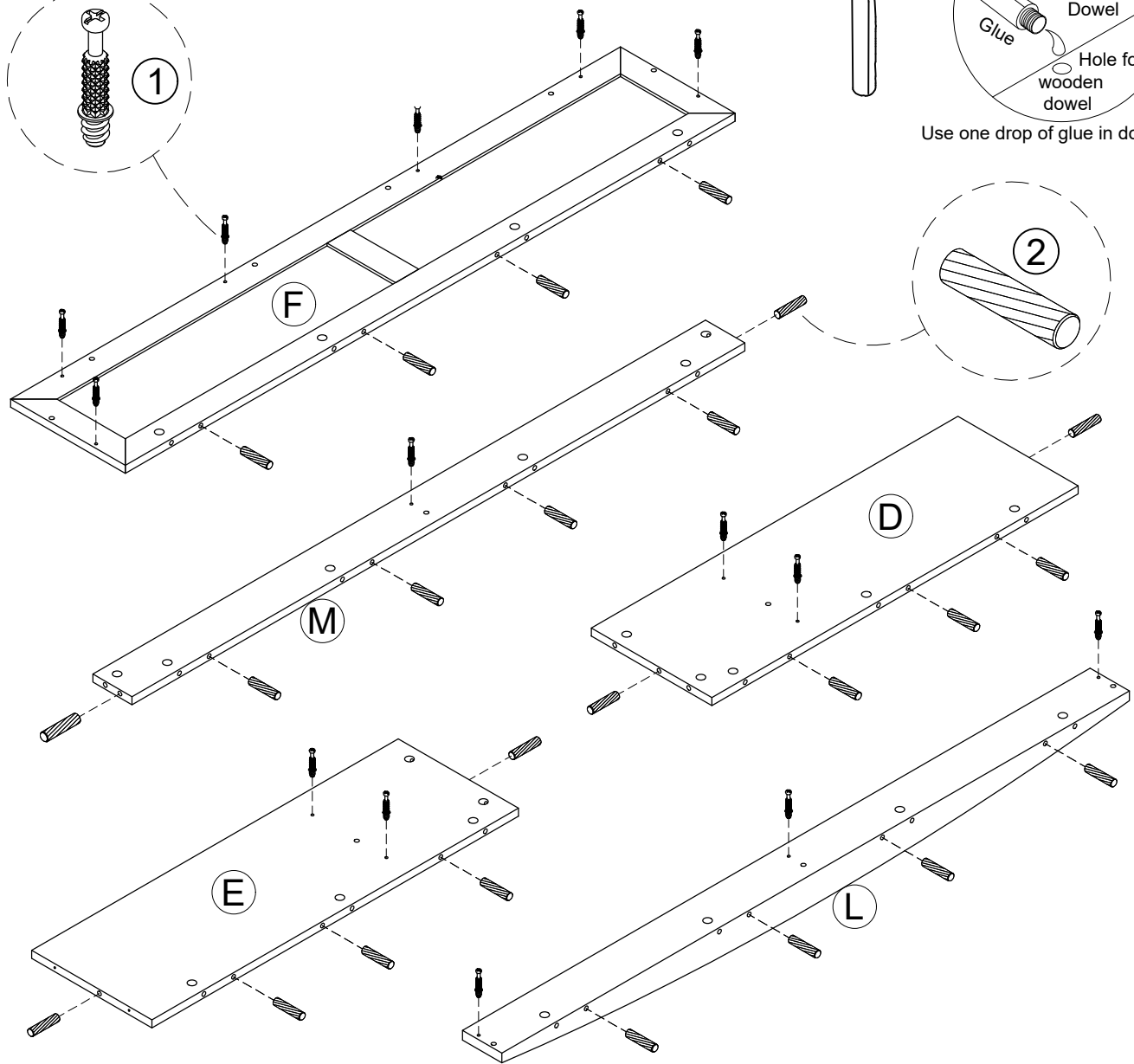
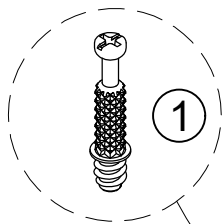

Use one drop of glue in dowel hole.

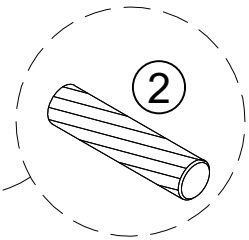

STEP 3

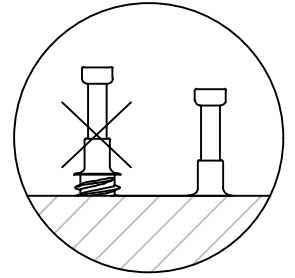
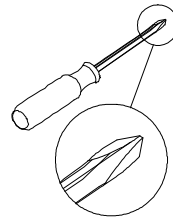
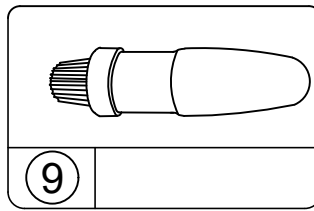
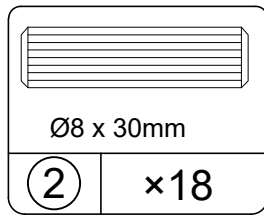
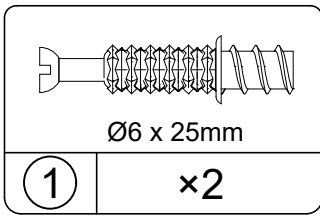

3.1 Attach (1) into (N), (P) as illustrated.

3.2 Insert (2) into (J), (K), (H), (N), (P) and (Q) as illustrated.

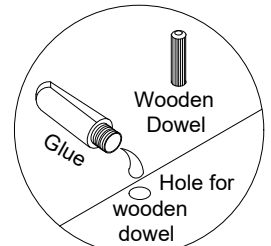

Use one drop of glue in dowel hole.

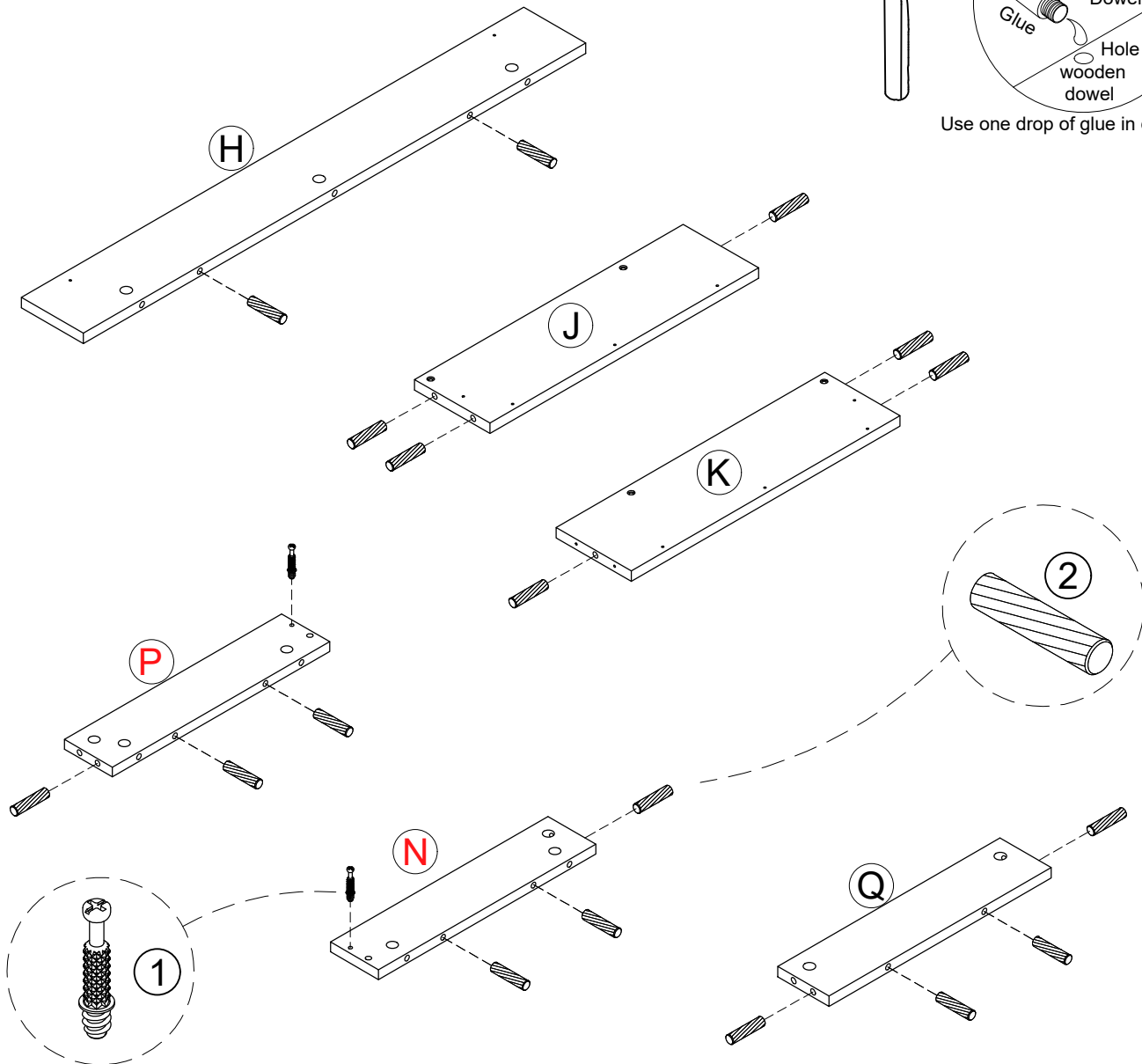

STEP 4

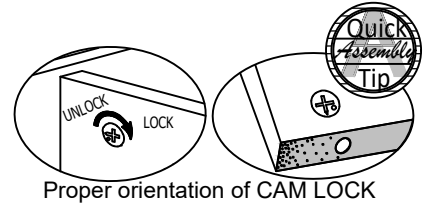
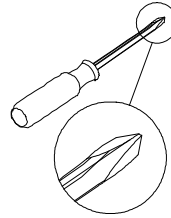
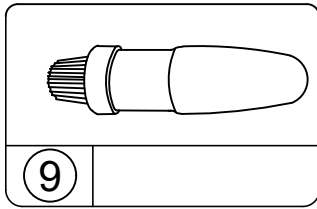
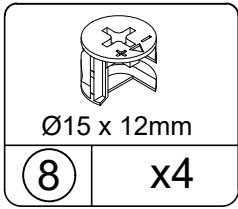

4.1 Attach (D), (E) into (C) with (8) as illustrated.

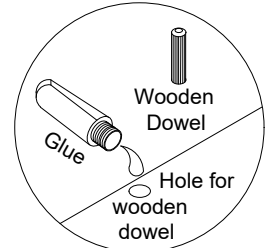

Use one drop of glue in dowel hole.

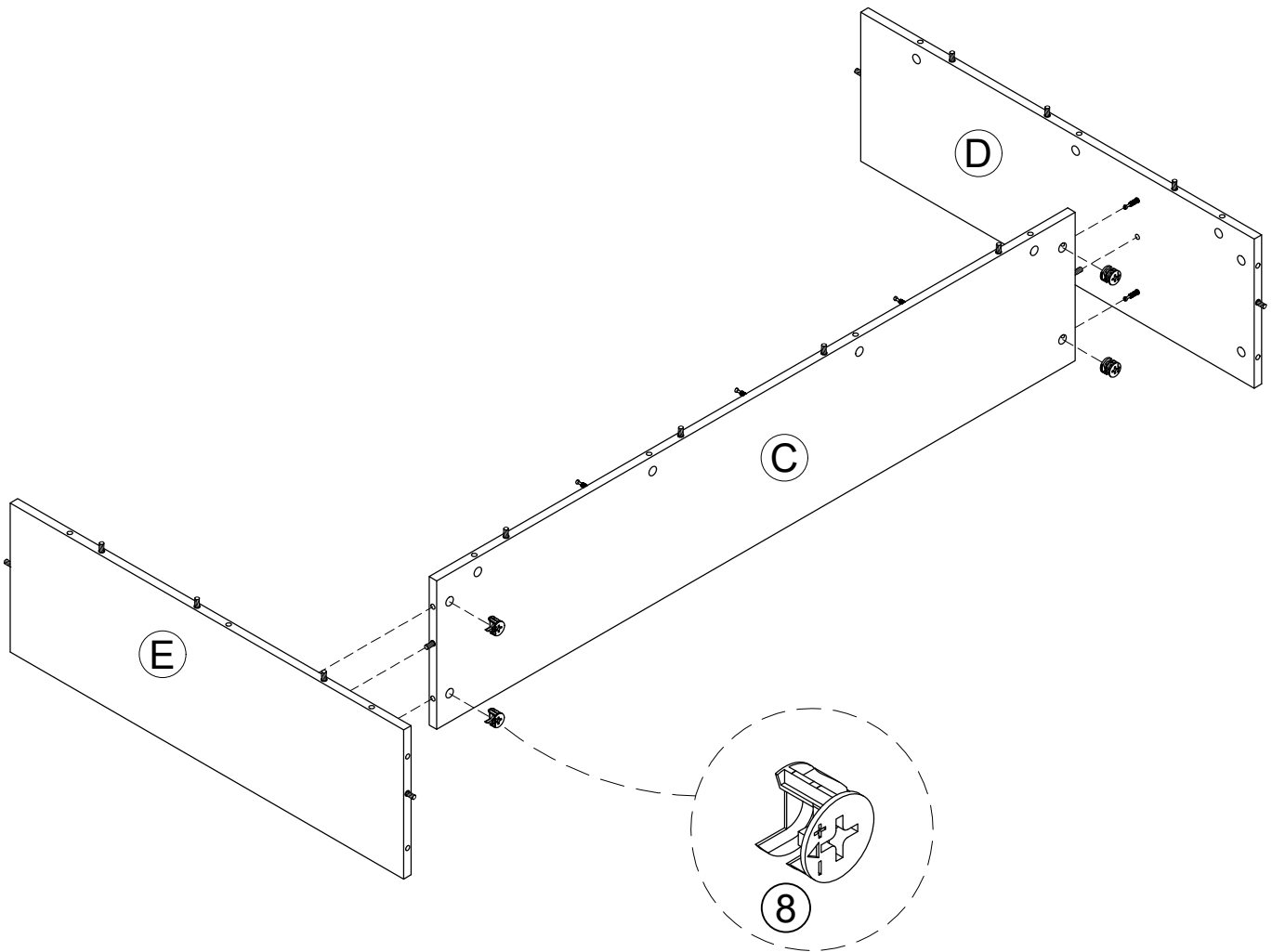

STEP 5

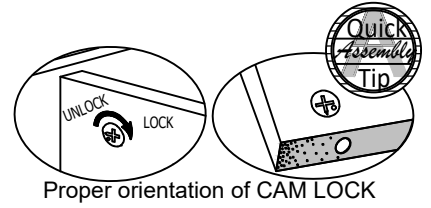
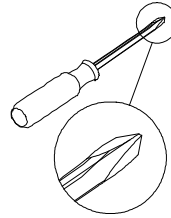
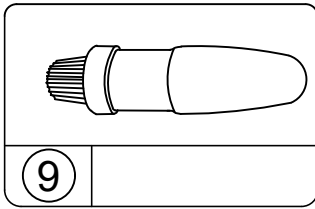
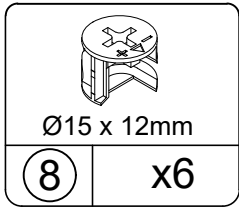

5.1 Attach (F) into (C), (D) and (E) with (8) as illustrated.

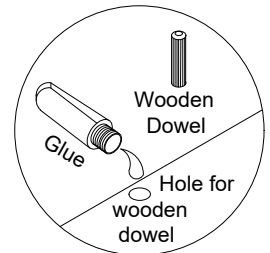

Use one drop of glue in dowel hole.

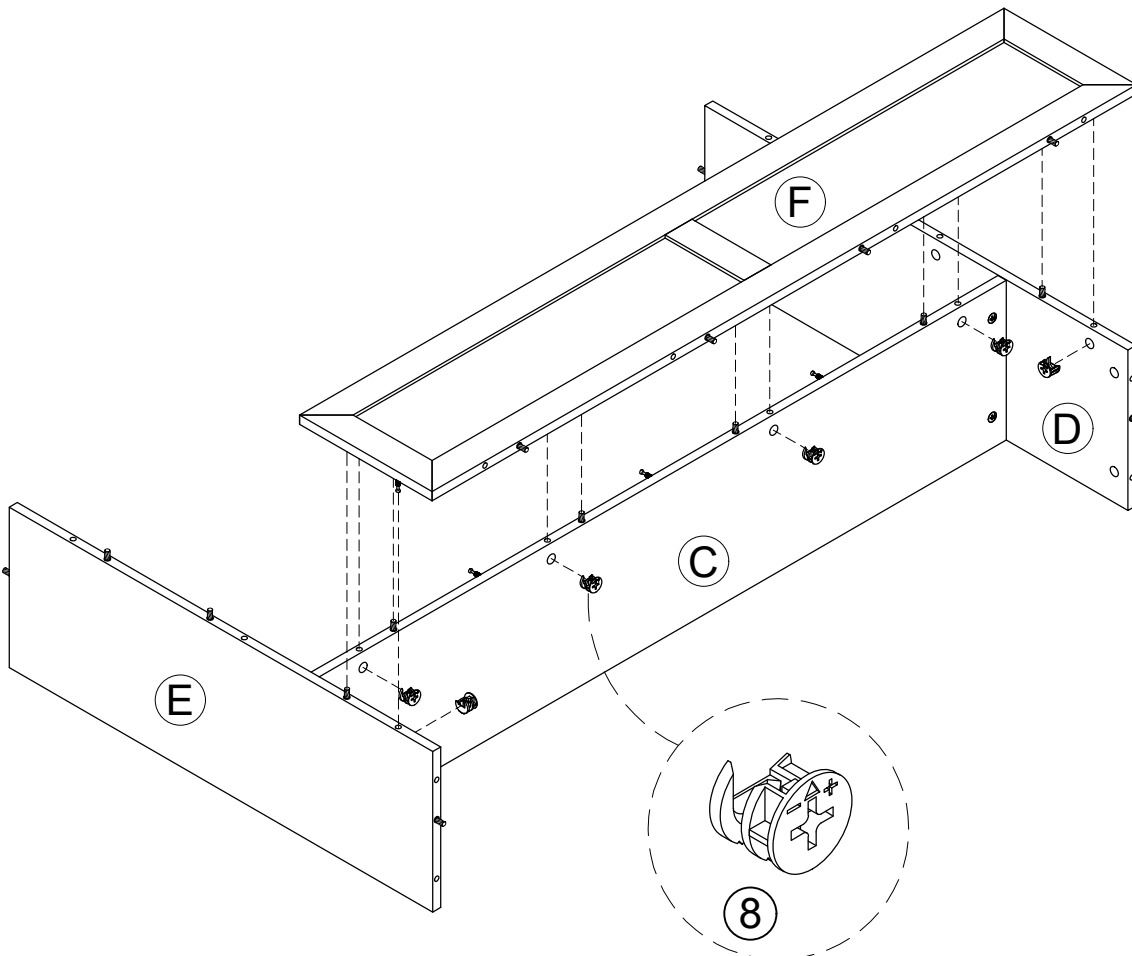

STEP 6

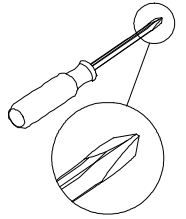
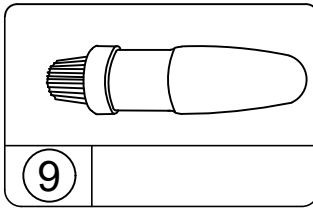
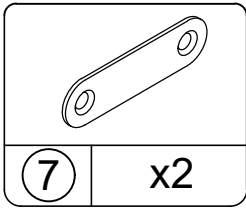
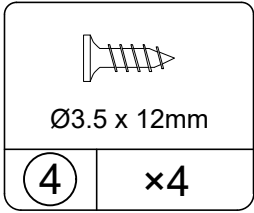

6.1 Attach (H) into (J), (K) with (4), (7) as illustrated.

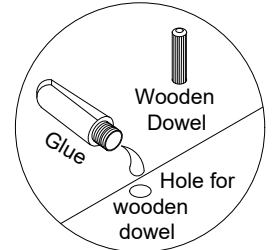

Use one drop of glue in dowel hole.

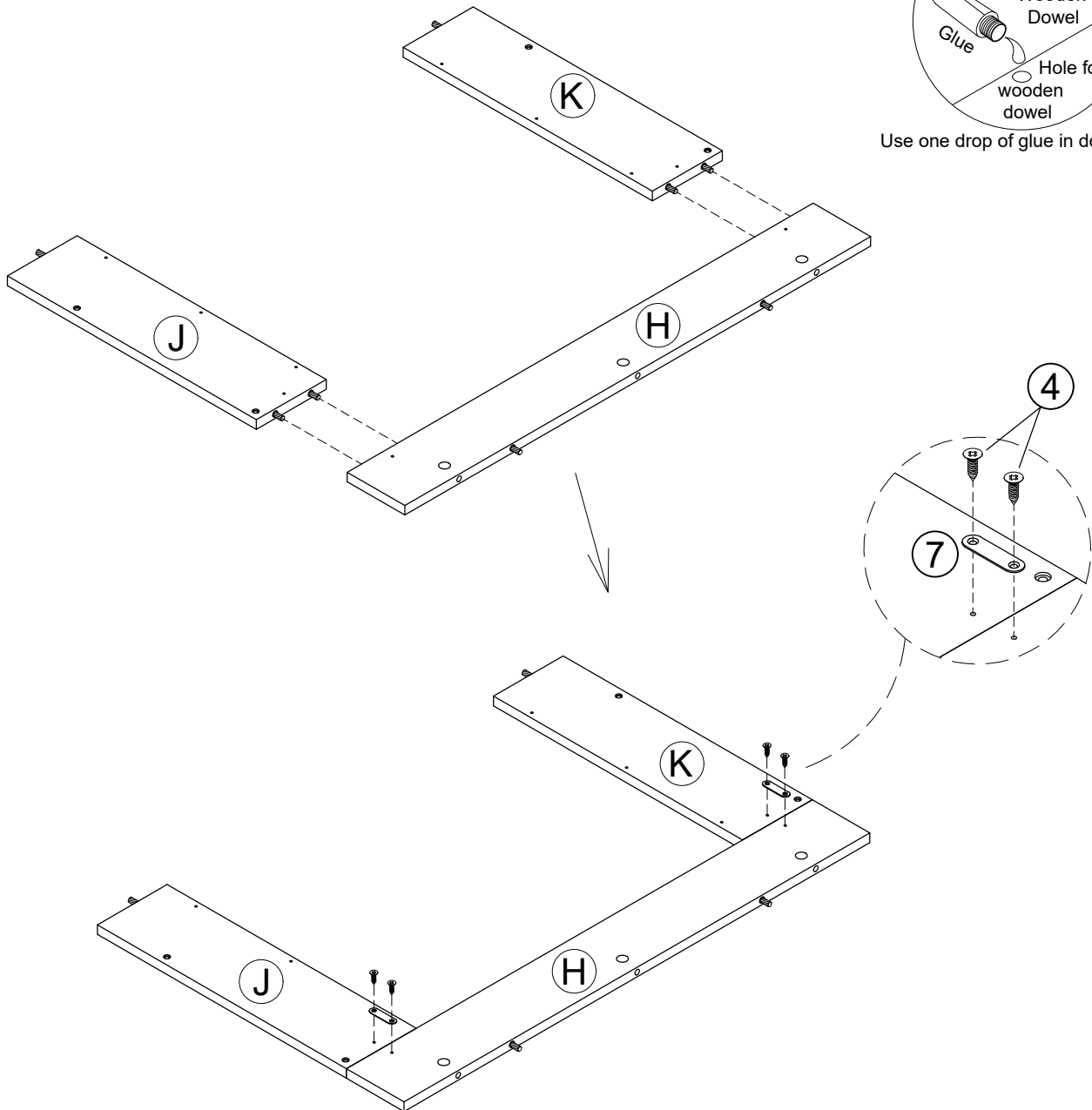

STEP 7

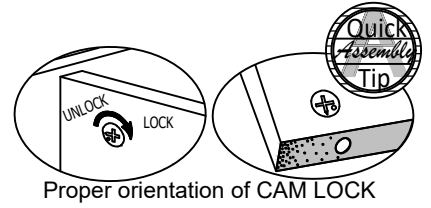
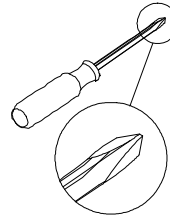
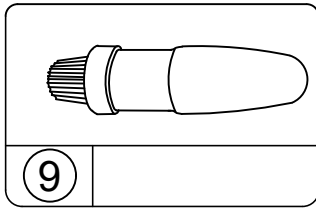
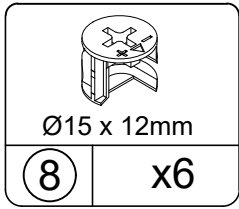

7.1 Attach (N), (P) and (Q) into (M) with (8) as illustrated.
7.2 Attach (L) into (N), (P) and (Q) with (8) as illustrated.

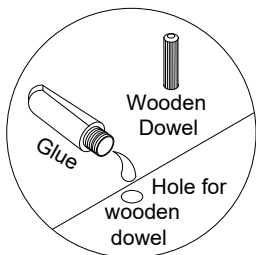
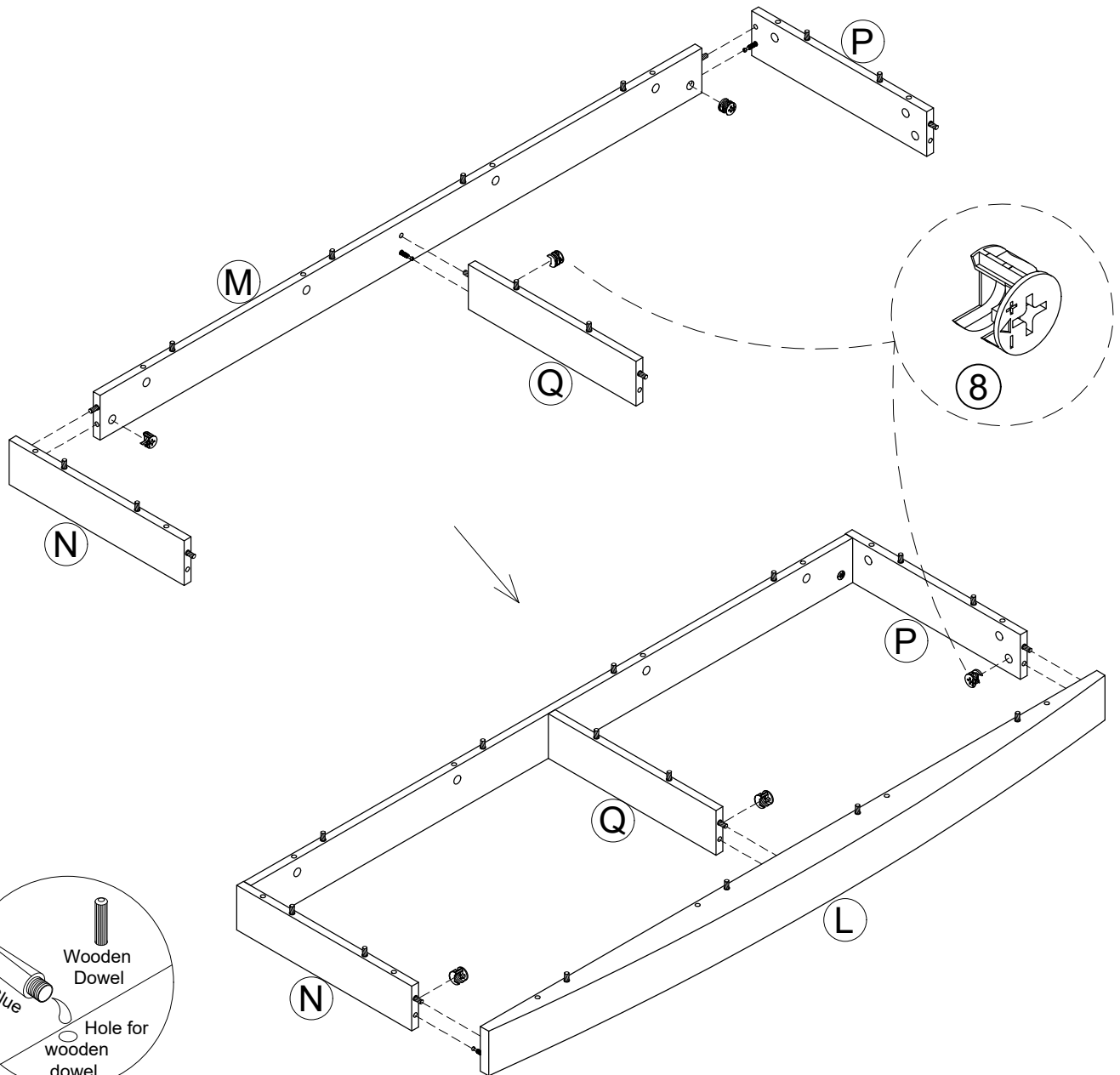

Use one drop of glue in dowel hole.

STEP 8

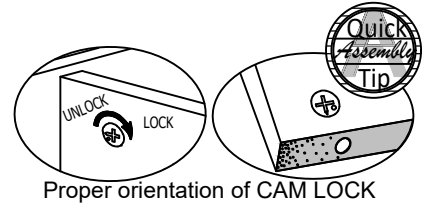
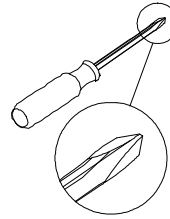
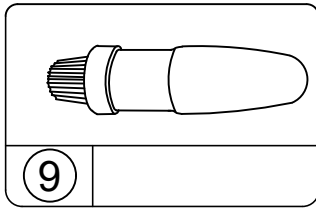
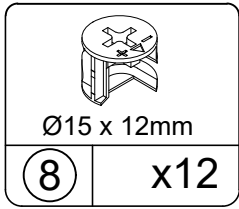

8.1 Attach (B) into (L), (M), (N), (P) and (Q) with (8) as illustrated.

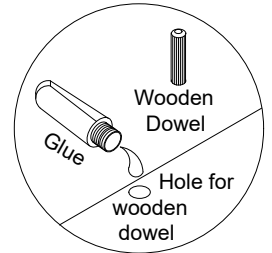

Use one drop of glue in dowel hole.

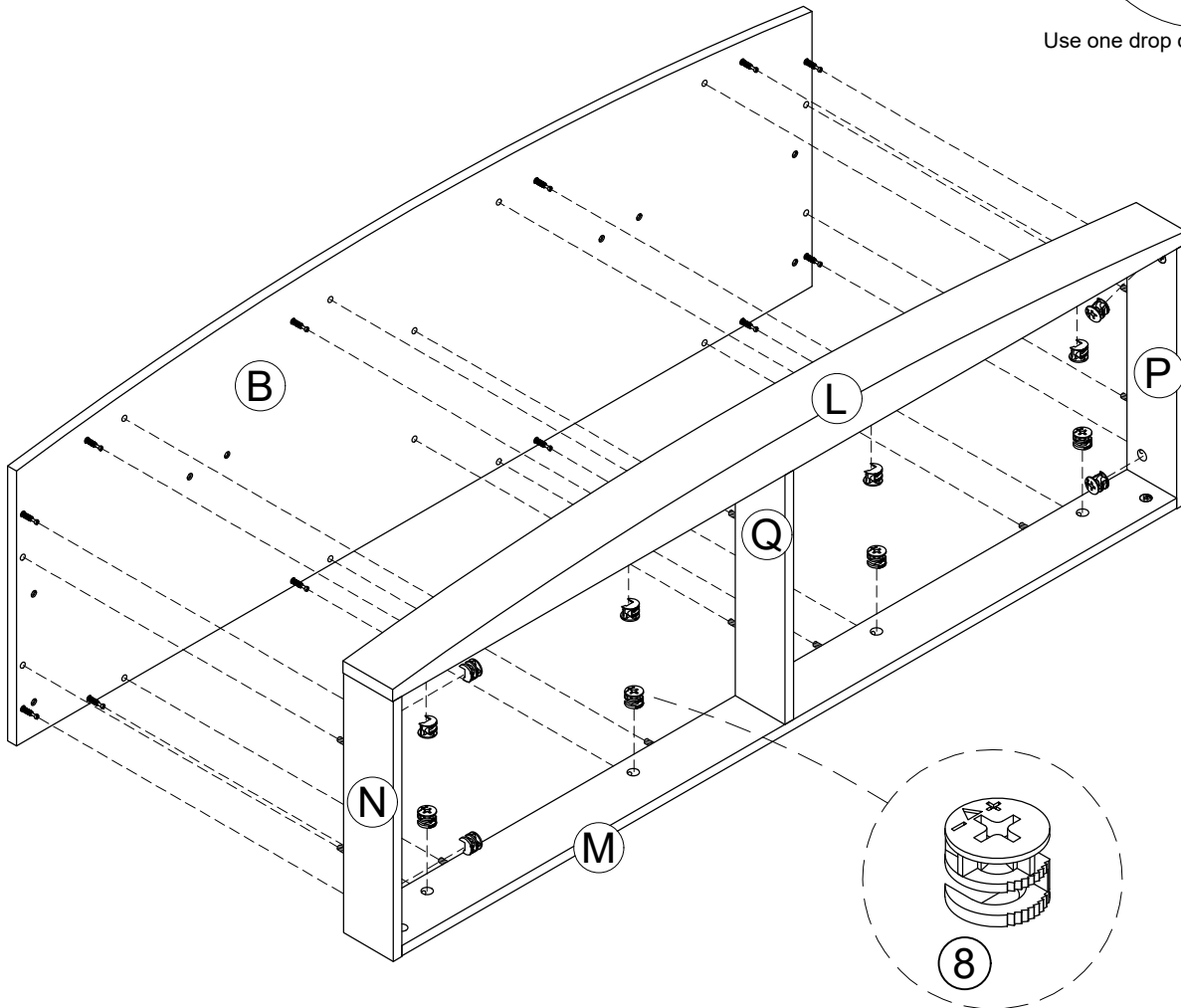

STEP 9

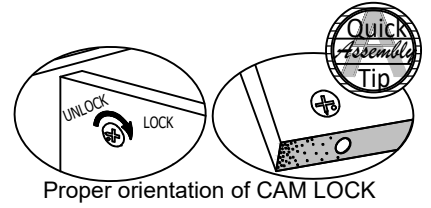
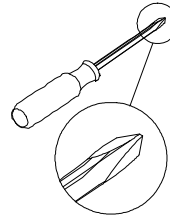
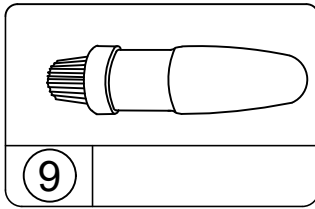
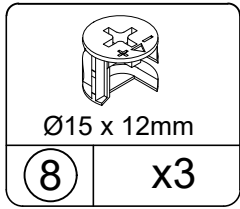

9.1 Attach (H) into (C) with (8) as illustrated.

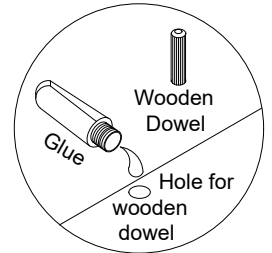

Use one drop of glue in dowel hole.

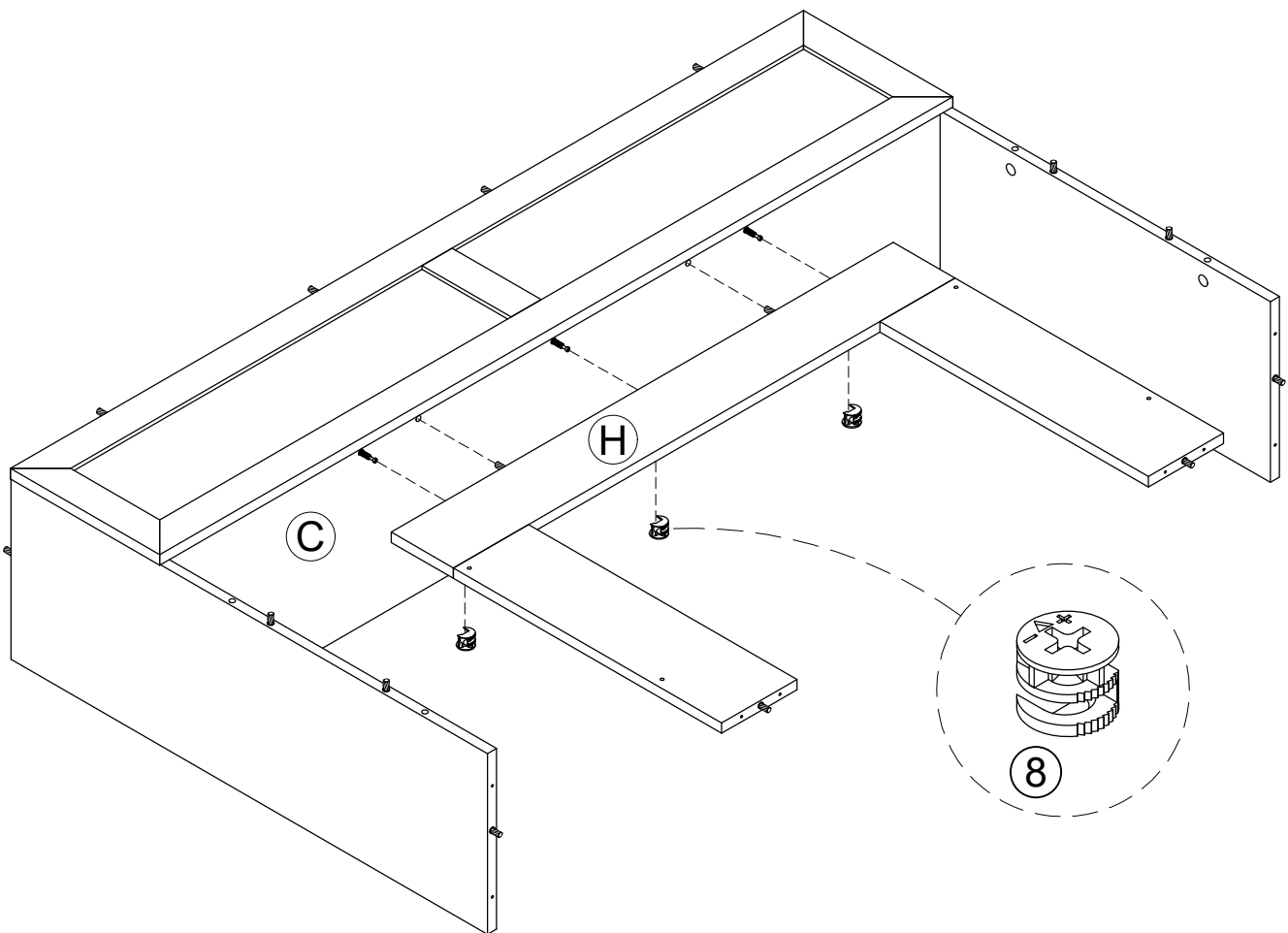

STEP 10

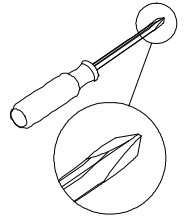
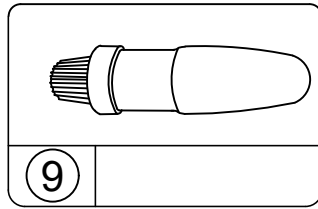
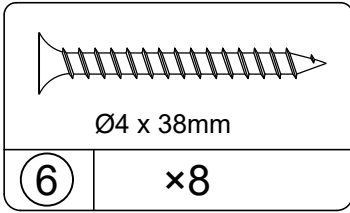

10.1 Attach base into (D), (E), (J), (K) with (6) as illustrated.

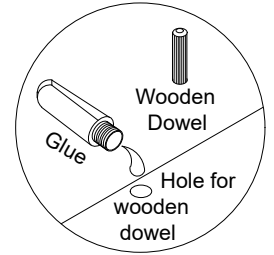

Use one drop of glue in dowel hole.

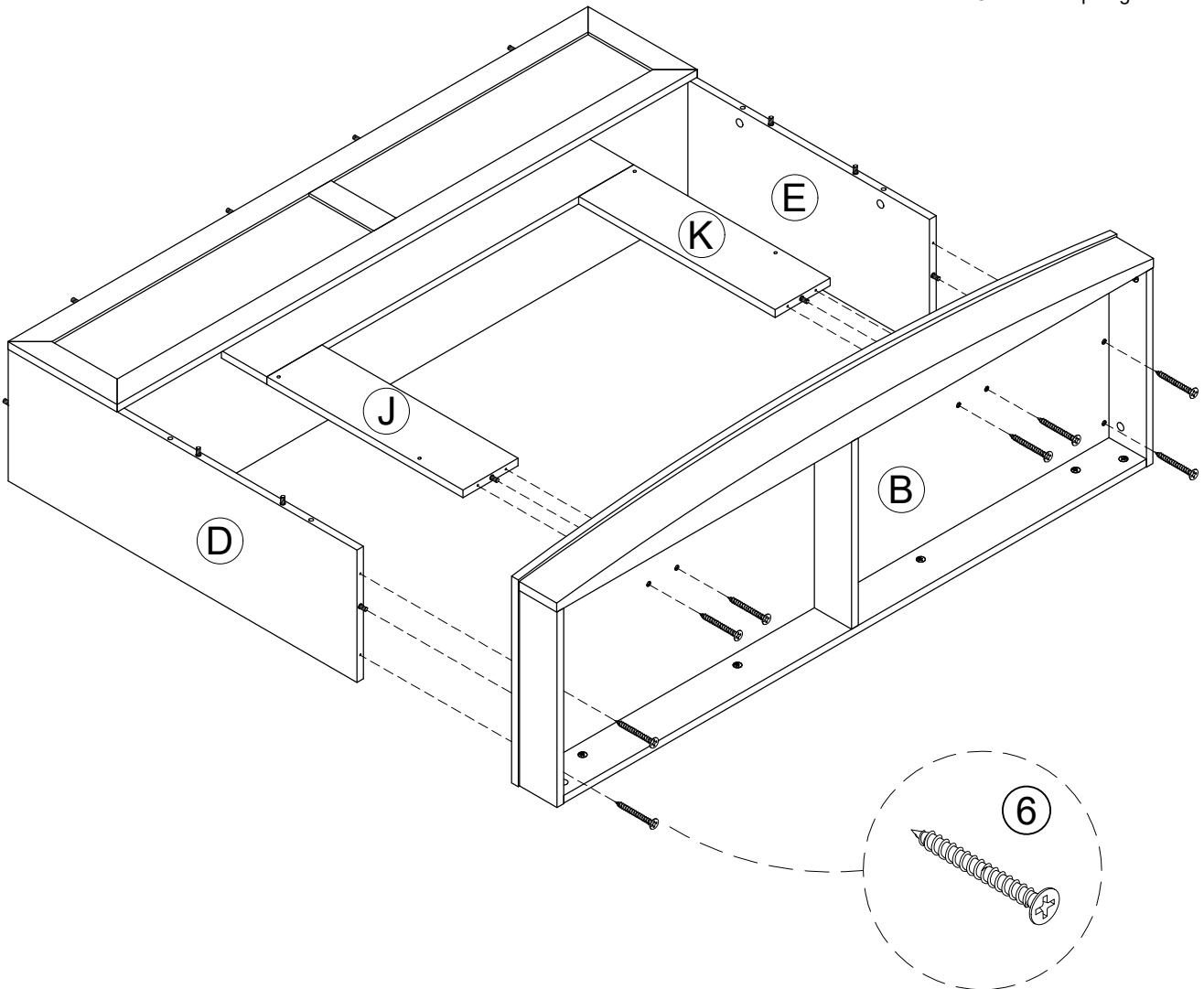

STEP 11

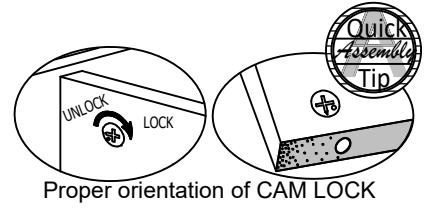
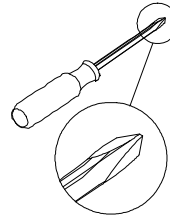
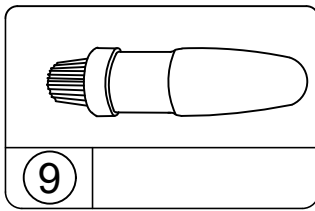
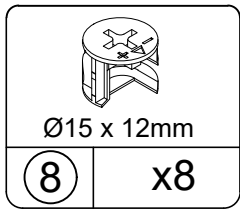

11.1 Attach (A) into (D), (E), (F) with (8) as illustrated.

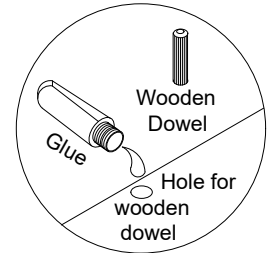
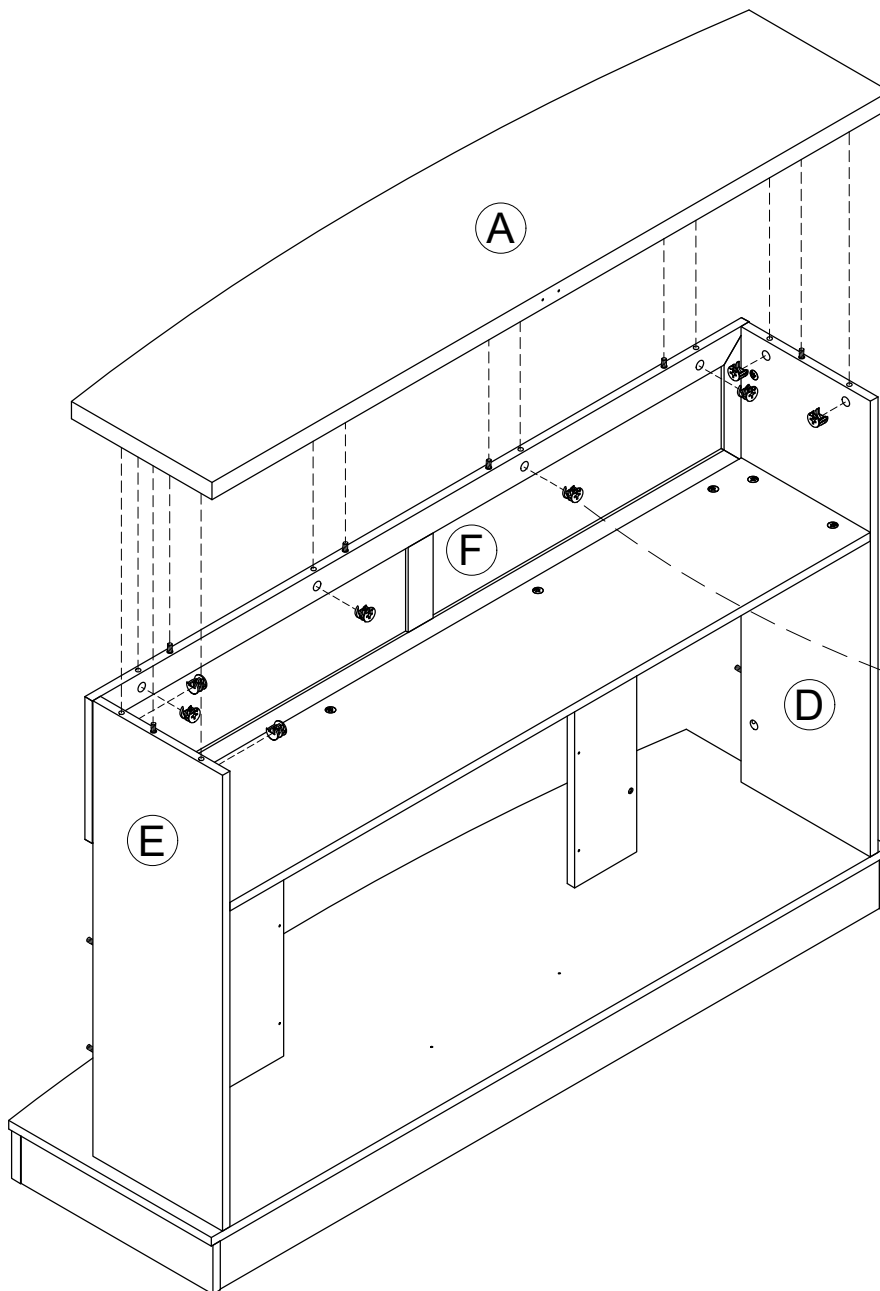

Use one drop of glue in dowel hole.

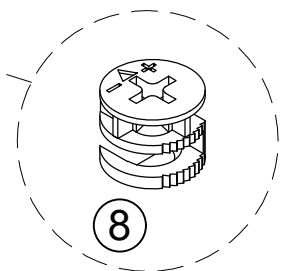

STEP 12

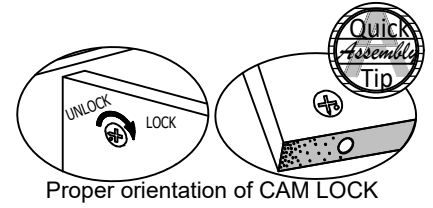
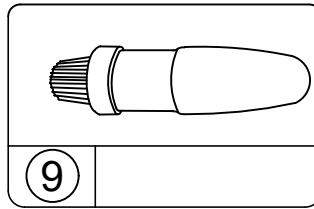
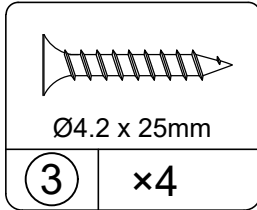
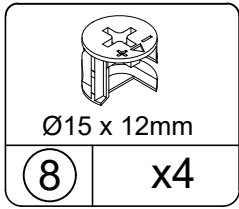

12.1 Attach (G) into (D), (J) with (3), (8) as illustrated.
 12.2 Attach (G) into (E), (K) with (3), (8) as illustrated.

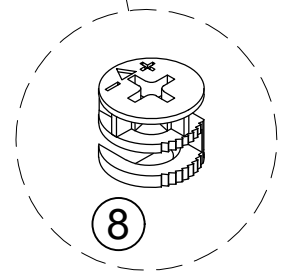
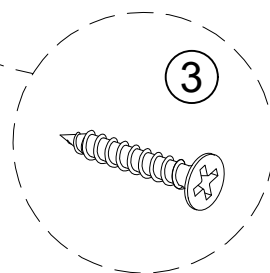
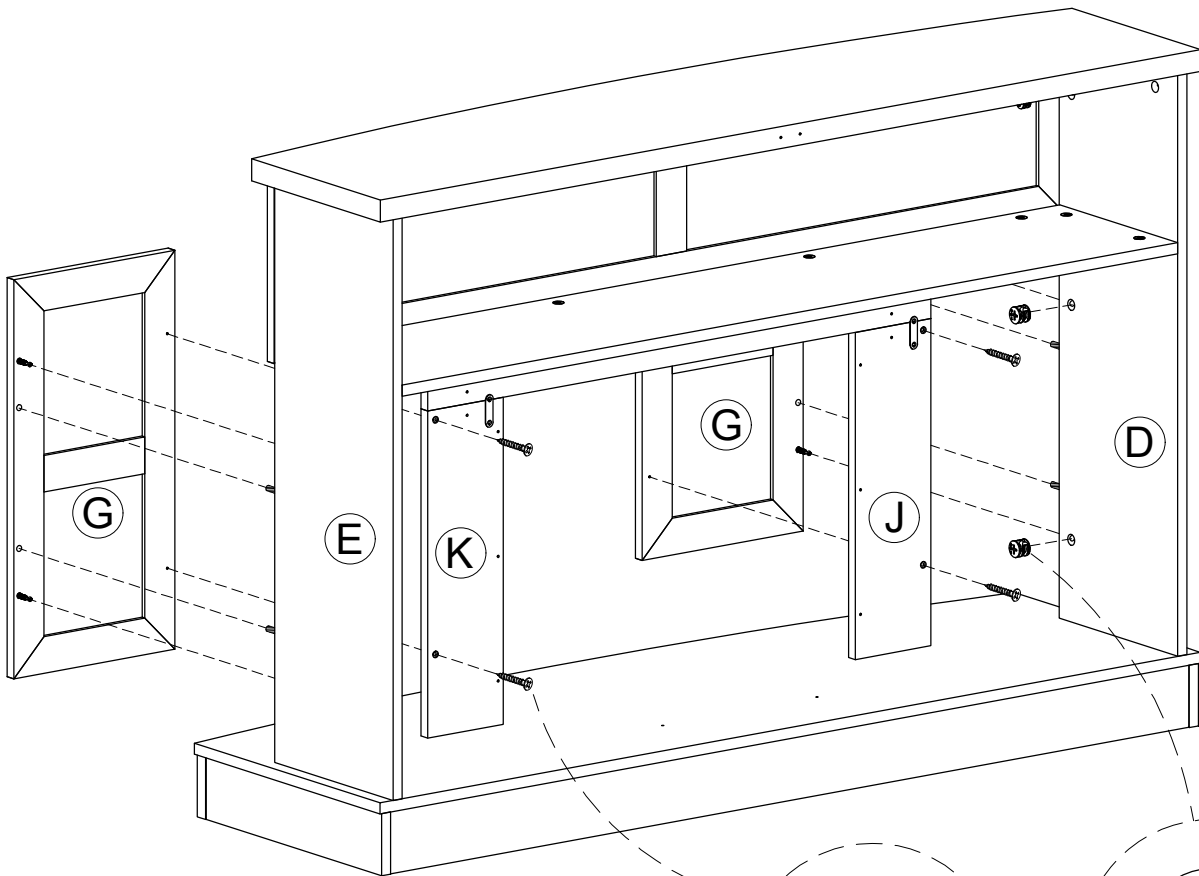
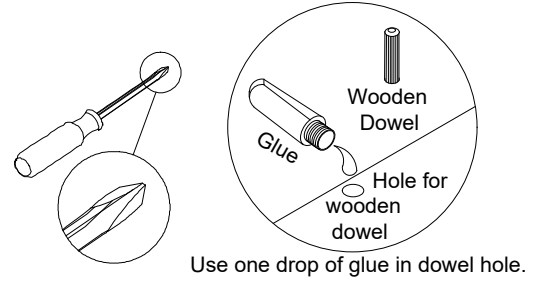

STEP 13

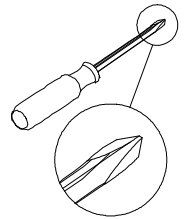
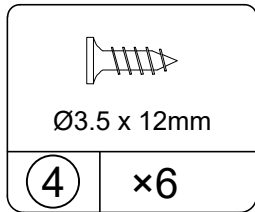

13.1 Attach (R) into (K), (J) with (4) as illustrated.

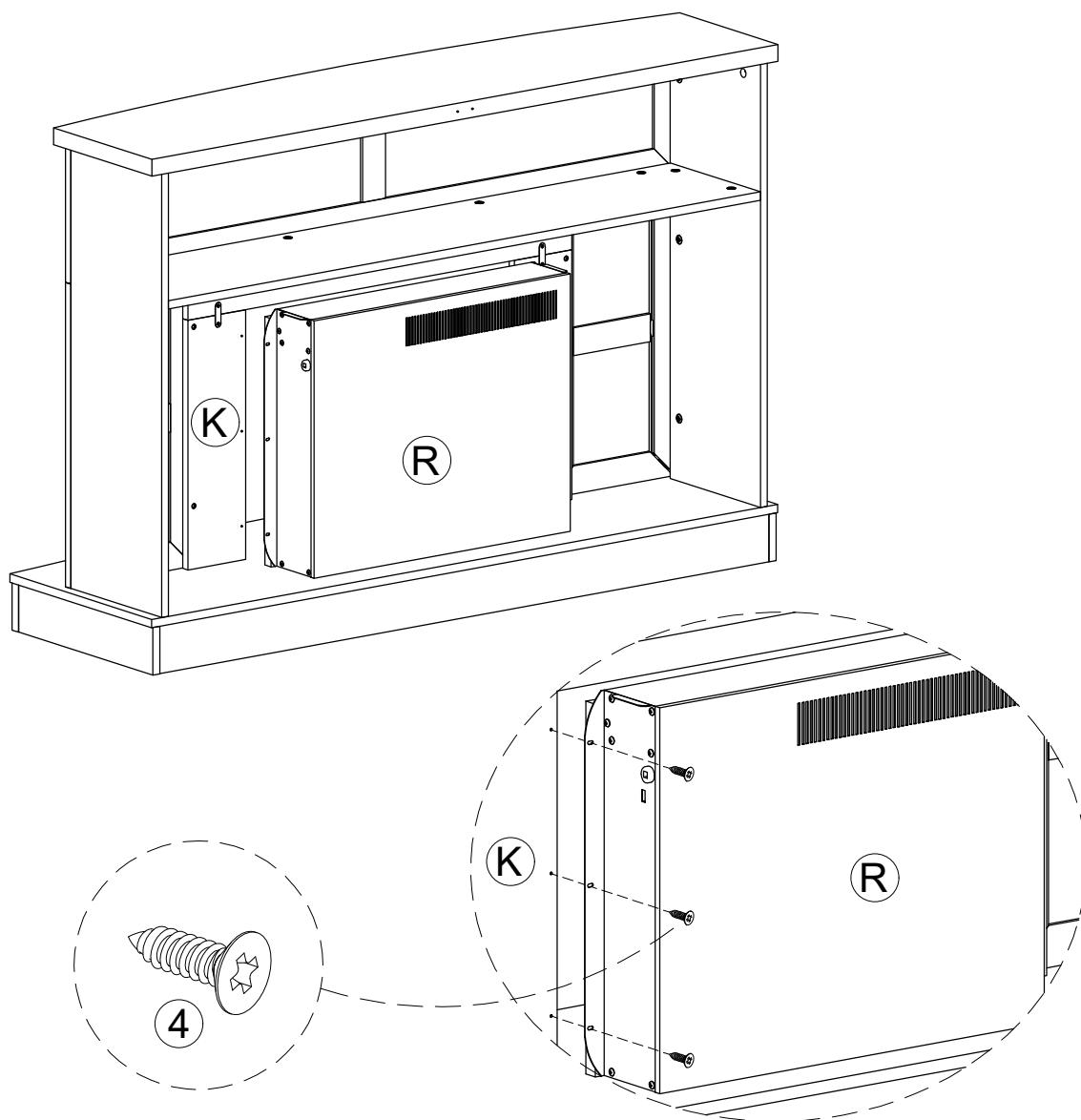

STEP 14

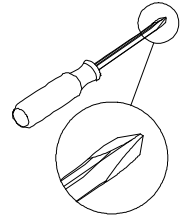
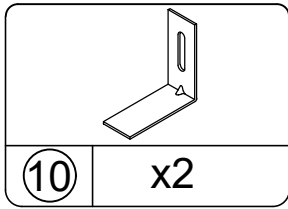
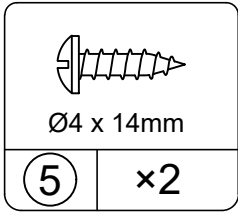

14.1 Attach (10) into (B) with (5) as illustrated.

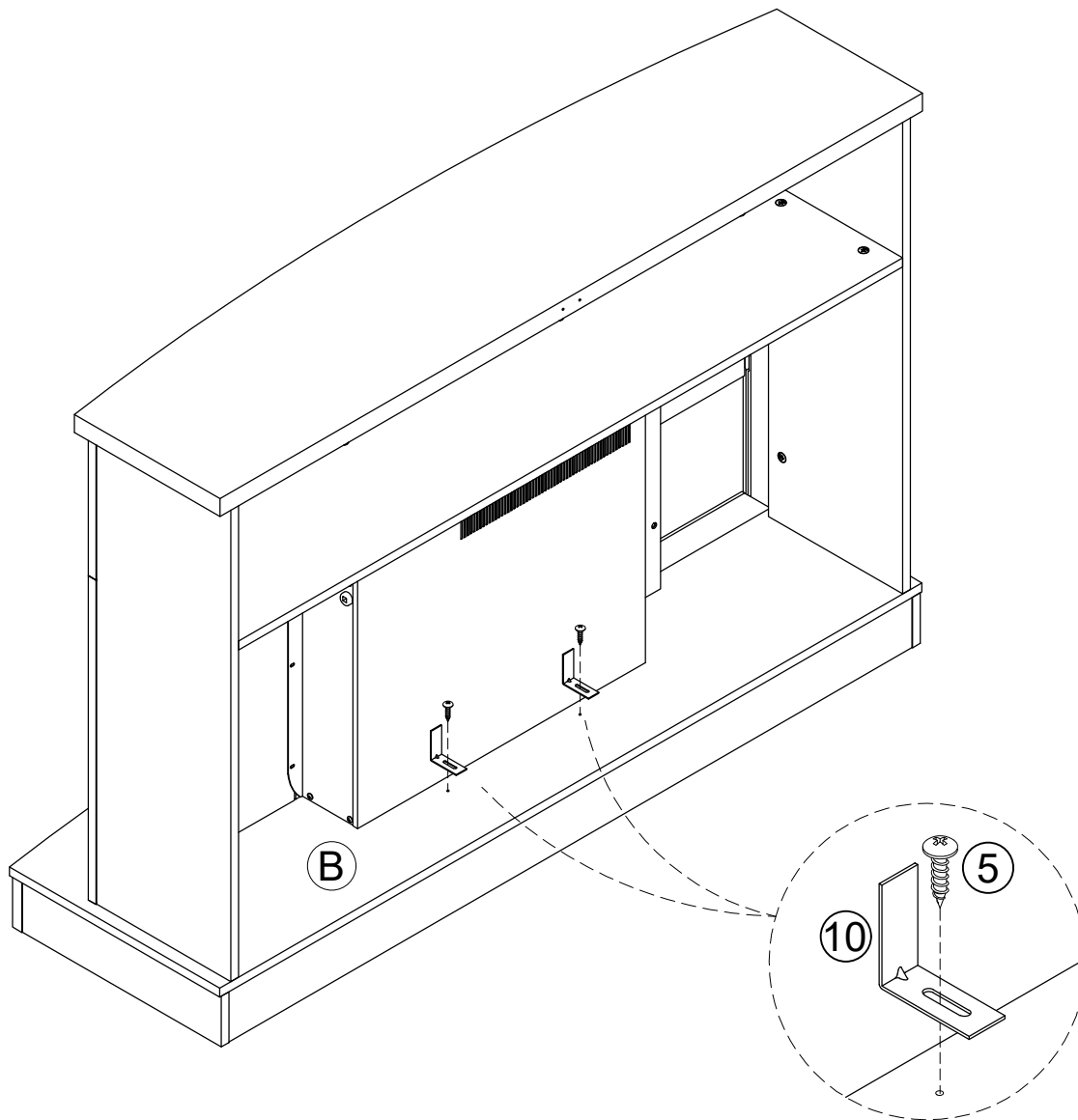

STEP 15

BEFORE CONNECTING THE UNIT TO A WALL ELECTRIC OUTLET:

Please carefully read and follow instructions and safety warnings in “Fireplace Homeowners Operating Manual” to operate your fireplace properly.

WARNING

IF THE INFORMATION IN THE FIREPALCE OPERATING MANUAL IS NOT FOLLOWED, AN ELECTRIC SHOCK OR FIRE MAY RESULT IN PROPERTY DAMAGE, PERSONAL INJURY, OR LOSS OF LIFE.

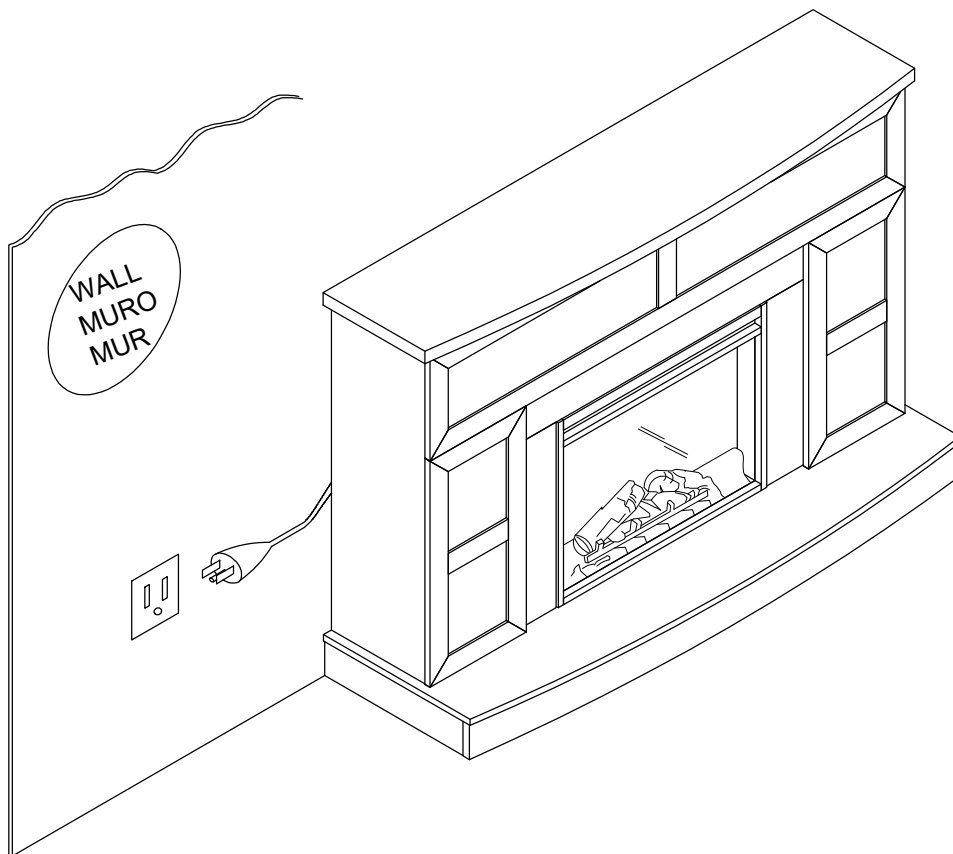

STEP 16

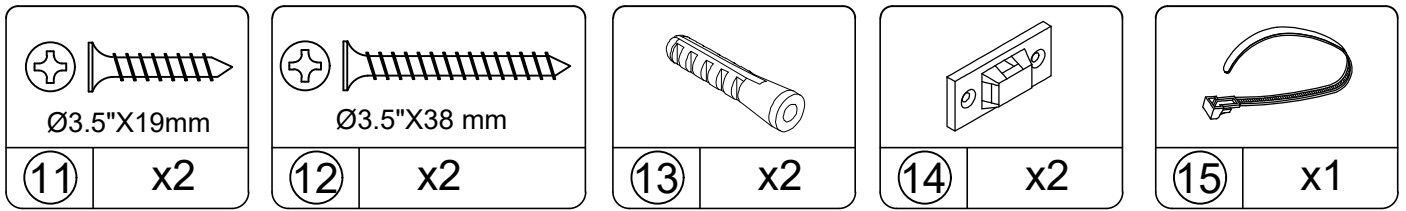

IMPORTANT: THIS UNIT MUST BE SECURE TO THE WALL TO HELP PREVENT TIPOVER. FOLLOW THESE INSTRUCTIONS TO INSTALL THE TIPPING RESTRAINT KIT PROVIDED WITH THIS PRODUCT:

OPTION 1: Attachment into a wall stud (preferred method)

Using a stud finder, locate a stud in the wall and mark the wall through the clip (14). Use screw (12) to attach the clip (14) to the wallboard. Use screw (11) to attach the clip (14) to the top shelf back. Move the furniture to its final position. Thread the strap (15) through the clip as shown in the illustration, tighten strap until snug. Do NOT over tighten.

OPTION 2: Attachment into drywall

Locate your unit where desired against a wall and mark the wall through the clip (14). Drill 5mm diameter holes (3/16") in the wallboard. Tap the wall anchor (13) into the hole until it is flush. Use screw (12) to attach the clip (14) to the wallboard. Use screw (11) to attach the clip (14) to the top shelf back. Move the furniture to its final position. Thread the strap (15) through the clip as shown in the illustration, tighten strap until snug. Do NOT over tighten.

For Masonry, Concrete, or other wall materials:

Consult your local hardware store for appropriate anchors to securely attach the safety bracket

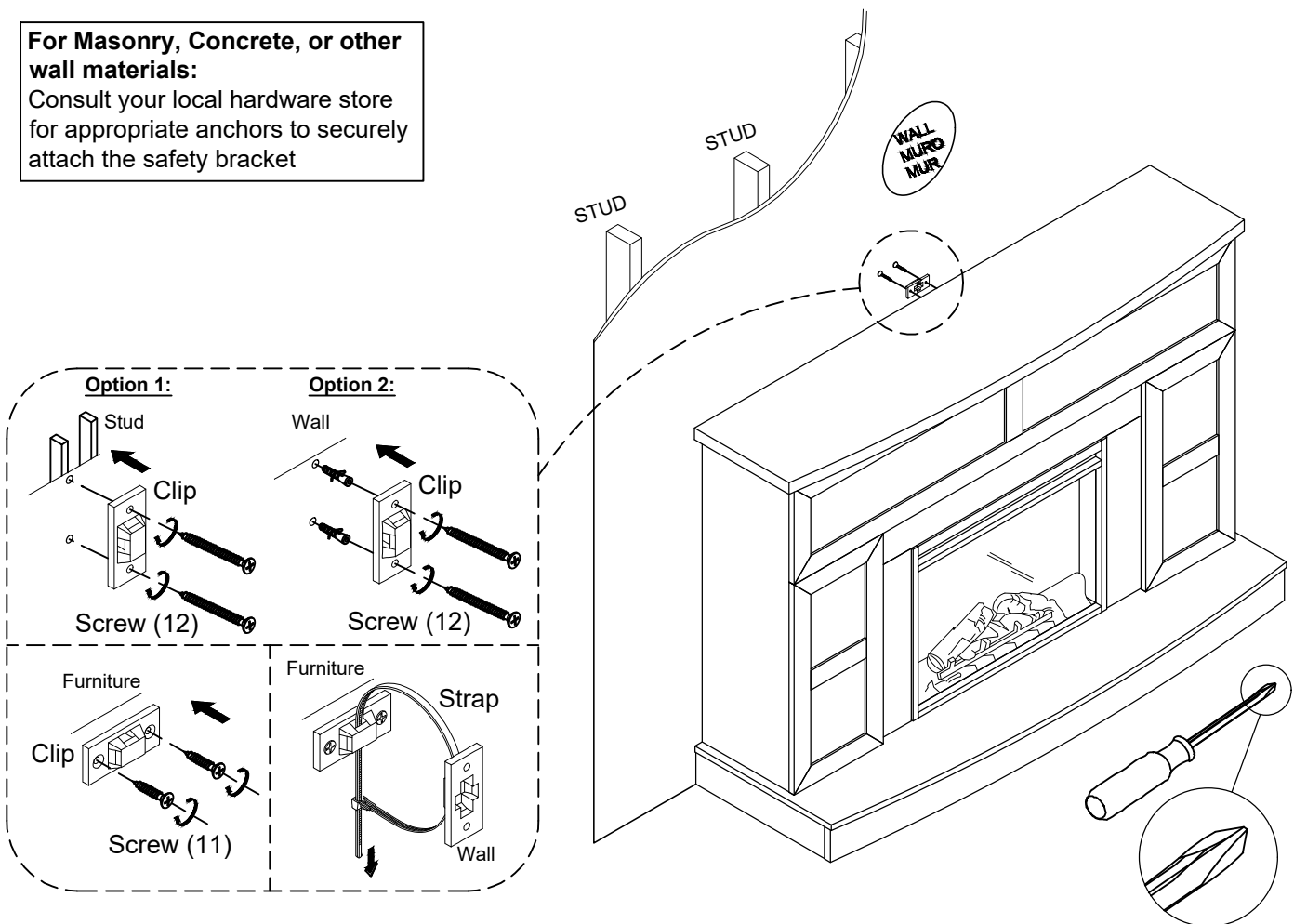

STEP 17

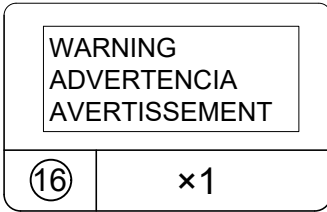

17.1 Apply the TV warning label to your unit so you'll always have the model's weight and TV size limits.
Maximum TV size: 60" flat screen

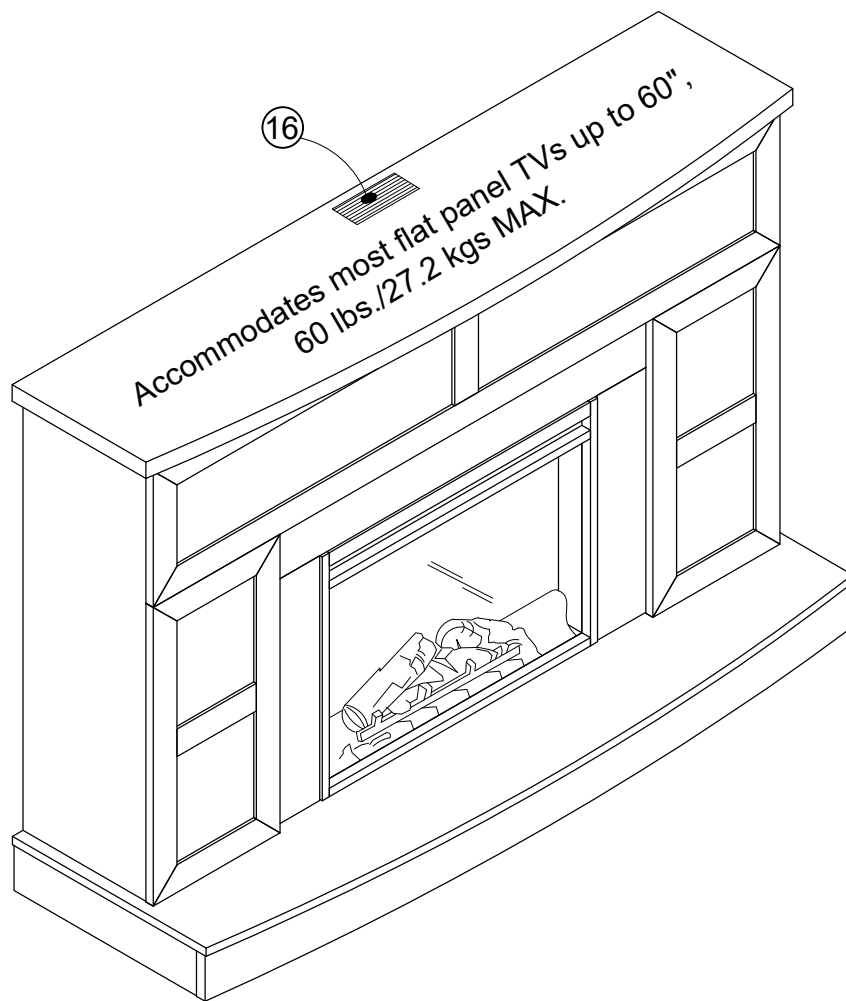

Maximum Loads

This unit has been designed to support the maximum loads shown. Exceeding these load limits could cause sagging, instability, product collapse, and/or serious injury.

Notice: Please apply the TV warning label (16) to your unit so you'll always have the model's weight and TV size limits.

Maximum TV size: 60" flat screen

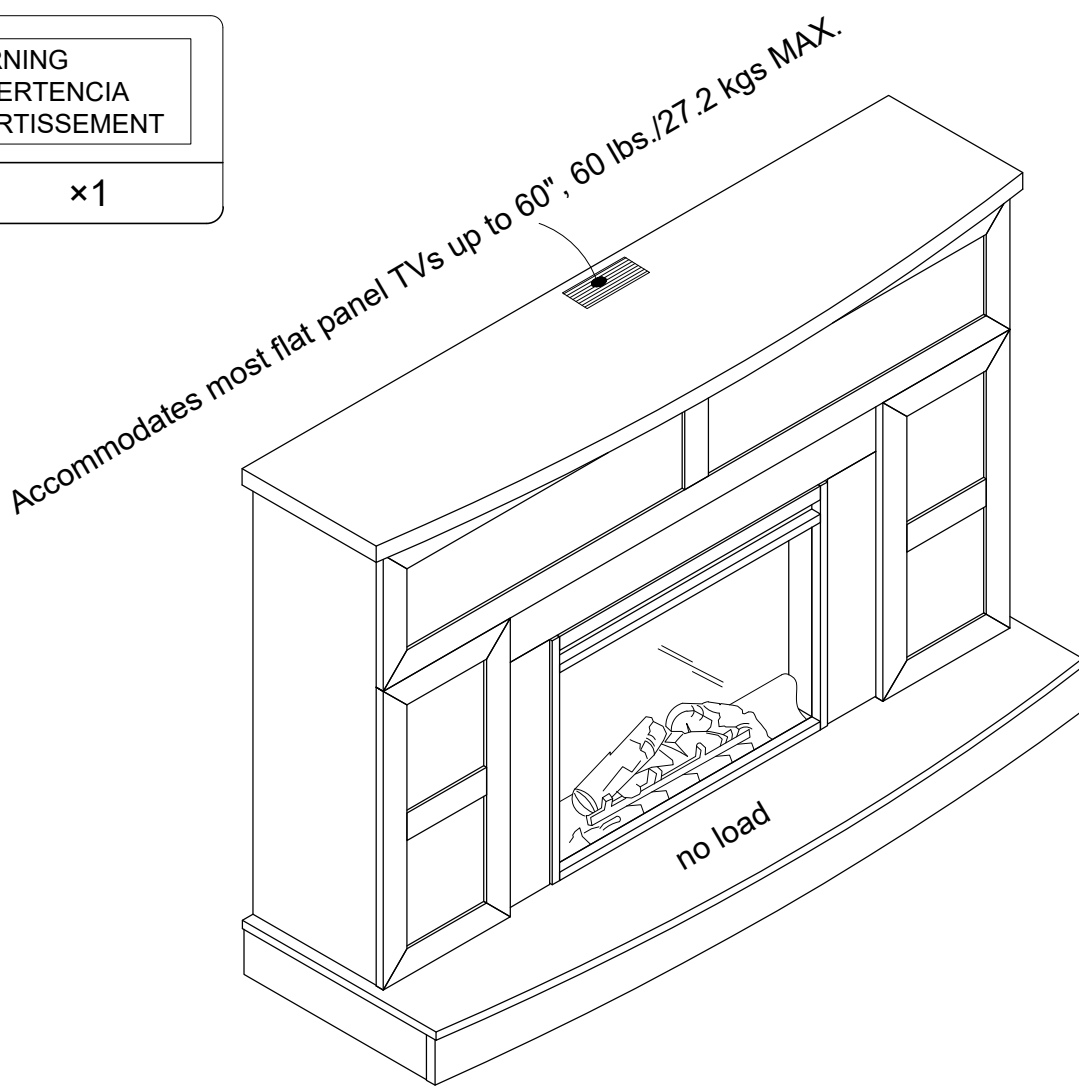
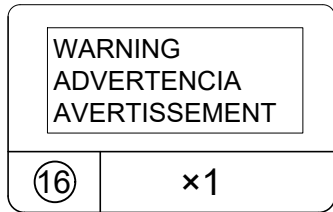

Certificate of Conformity

1. This certificate applies to the Dorel Home Furnishings, Inc. product identified by this instruction manual.
2. This certificate applies to compliance of this product with the CPSC Ban on Lead-Containing Paint (16 CFR 1303).
3. This product is distributed by: Dorel Home Furnishings, Inc.
 410 East First Street South
 Wright City, MO 63390
 636-745-3351
4. Site of Manufacture: Binh Duong, Viet Nam.
5. See front page of instruction manual for date of manufacture.

Register your product to receive the following:



- * New trend details - sneak peek on what's new
- * Surveys - have a voice within our community
- * Exclusive deals and discount codes
- * Quick and easy replacement part service

To register your product, visit ameriwoodhome.com

5 Star Rating



Visit your local retailer's website, rate your purchased product and leave us some feedback!

We would like to extend a big "Thank You" to all of our customers for taking the time to assemble this Ameriwood Home product, and to give us your valuable feedback.

*Thank
You!*

Cubierta Delantera

Este libro de instrucciones contiene información **IMPORTANTE** de seguridad. Por favor lea y manténgalo para referencia en el futuro.

No Regrese este producto! Comuníquese con nuestro amistoso equipo de servicio al cliente para obtener ayuda.

Llámenos al: 1-800-489-3351 (Gratis) Lunes - Viernes 9am - 5pm CST

Visitar: www.ameriwoodhome.com

PRECAUCION

Este mueble puede volcarse y causar graves heridas y/o muerte.

Anclar el mueble a un poste de madera en la pared (si esto se requiere).

No Permita que los niños monten el mueble.

Mantenga los artículos más pesados en los cajones de abajo.

Consejos Útiles (página 2)

- Abra su artículo en el área donde usted planea utilizarlo para evitar levantar y moverlo menos
- Identificar, ordenar y contar las piezas antes de intentar ensamblar
- Las clavijas de compresión se golpean con un martillo
- Las diapositivas están marcadas con una R (derecha) y L (izquierda) para la colocación correcta
- Asegúrese de que siempre este el punto localizado en la parte superior de bloqueador de leva este volteado hacia borde exterior
- Utilizar todos los clavos para el panel de atrás y distribuirlos por igual
- El panel de atrás debe utilizarse para asegurarse de que la unidad quede fija y firme
- No use químicas fuertes ni limpiadores abrasivos en este artículo
- Nunca empuje, tire ni arrastre los muebles

Antes de Que Empieces (página 3)

- Lea cuidadosamente cada paso y siga el orden correcto

- Separar y contar todas sus piezas y hardware

- Dése suficiente espacio para el proceso de ensamble

- Tenga las siguientes herramientas: destornillador de cabeza plana, #2 cabeza Phillips

Destornillador y martillo

- Precaución: Si usa un taladro electrónico o un destornillador eléctrico para atornillar, por favor asegúrese que deje de atornillar cuando el tornillo este apretado. Fallar hacer esto puede causar barrer el tornillo.

Sistema de fijar el bloqueo de leva (página 3)

Esta sistema de fijar el bloqueo de leva sera usado en todo el proceso ensamble.

Identificación de los Paneles (Página 4-5)

Este no es el tamaño real

- (A) ARRIBA
- (B) INFERIOR
- (C) ESTANTE
- (D) LADO IZQUIERDO
- (E) LADO DERECHO
- (F) MARCO SUPERIOR
- (G) BASTIDOR INFERIOR
- (H) PANEL FRONTAL
- (J) PANEL DELANTERO IZQUIERDO
- (K) PANEL DELANTERO DERECHO
- (L) PANEL DE PATADA
- (M) SOPORTE TRASERO
- (N) PANEL BASE IZQUIERDO
- (P) PANEL BASE DERECHO
- (Q) PANEL BASE CENTRAL
- (R) CHIMENEA

Lista de Piezas (Página 6)

Tamaño real

- (1) Perno de leva
- (2) Taco de madera
- (3) Tornillo
- (4) Tornillo
- (5) Tornillo
- (6) Tornillo

Lista de Piezas (Página 6)

Este no es el tamaño real

- (7) Placa de metal
- (8) Bloqueo de leva
- (9) Pegamento
- (10) Soporte angular
- (11) Tornillo
- (12) Tornillo
- (13) Anclaje de pared
- (14) Clip
- (15) Correa
- (16) Etiqueta de advertencia

Página 7

- 1.1 Fije (1) en (A), (B), (C) y (G) como se ilustra.
- 1.2 Inserte (2) en (C) como se ilustra.

Página 8

- 2.1 Fije (1) en (D), (E), (F), (L) y (M) como se ilustra.
- 2.2 Inserte (2) en (D), (E), (F), (L) y (M) como se ilustra.

Página 9

- 3.1 Fije (1) en (N), (P) como se ilustra.
- 3.2 Inserte (2) en (J), (K), (H), (N), (P) y (Q) como se ilustra.

Página 10

- 4.1 Fije (D), (E) en (C) con (8) como se ilustra.

Página 11

- 5.1 Fije (F) en (C), (D) y (E) con (8) como se ilustra.

Página 12

- 6.1 Fije (H) en (J), (K) con (4), (7) como se ilustra.

Página 13

- 7.1 Fije (N), (P) y (Q) en (M) con (8) como se ilustra.
- 7.2 Fije (L) en (N), (P) y (Q) con (8) como se ilustra.

Página 14

- 8.1 Fije (B) en (L), (M), (N), (P) y (Q) con (8) como se ilustra.

Página 15

- 9.1 Fije (H) en (C) con (8) como se ilustra.

Página 16

10.1 Fije la base en (D), (E), (J), (K) con (6) como se ilustra.

Página 17

11.1 Fije (A) en (D), (E), (F) con (8) como se ilustra.

Página 18

12.1 Fije (G) en (D), (J) con (3), (8) como se ilustra.

12.2 Fije (G) en (E), (K) con (3), (8) como se ilustra.

Página 19

13.1 Fije (R) en (K), (J) con (4) como se ilustra.

Página 20

14.1 Fije (10) en (B) con (5) como se ilustra.

Página 21

ANTES DE CONECTAR LA UNIDAD A UN TOMA DE CORRIENTE DE PARED:

Lea atentamente y siga las instrucciones y advertencias de seguridad en el "Manual de funcionamiento de la chimenea para propietarios" para operar su chimenea correctamente.

ADVERTENCIA:

SI NO SE SIGUE LA INFORMACIÓN DEL MANUAL DE FUNCIONAMIENTO DE FIREPALCE, UNA DESCARGA ELÉCTRICA O INCENDIO PUEDE RESULTAR EN DAÑOS A LA PROPIEDAD, LESIONES PERSONALES O LA PÉRDIDA DE LA VIDA.

Página 22

IMPORTANTE: ESTA UNIDAD DEBE ESTAR FIJADA A LA PARED PARA AYUDAR A EVITAR VUELCOS. SIGUE ESTOS

INSTRUCCIONES PARA INSTALAR EL KIT DE RETENCIÓN DE VUELCO SUMINISTRADO CON ESTE PRODUCTO:

OPCIÓN 1: Fijación en un montante de pared (método preferido)

Usando un detector de vigas, ubique una viga en la pared y marque la pared a través del clip (14). Utilice el tornillo (12) para sujetar el clip (14) al panel de yeso. Use el tornillo (11) para sujetar el clip (14) a la parte posterior del estante superior. Mueva los muebles a su posición final. Pase la correa (15) a través del clip como se muestra en la ilustración, apriete la correa hasta que quede ajustada. NO apriete demasiado.

OPCIÓN 2: Fijación en paneles de yeso

Ubique su unidad donde desee contra una pared y marque la pared a través del clip (14). Taladre orificios de 5 mm de diámetro (3/16") en el panel de yeso. Golpee el anclaje de pared (13) en el orificio hasta que quede al ras. Use el tornillo (12) para fijar el clip (14) al panel de yeso. Use el tornillo (11) para sujetar el clip (14) a la parte posterior del estante superior. Mueva el mueble a su posición final. Pase la correa (15) a través del clip como se muestra en la ilustración, apriete la correa hasta que quede ajustada. NO apriete demasiado.

Para mampostería, hormigón u otros materiales de pared:

Consulte en su ferretería local los anclajes apropiados para sujetar de forma segura el soporte de seguridad.

Página 23

17.1 Aplique la etiqueta de advertencia de TV a su unidad para que siempre tenga los límites de peso y tamaño de TV del modelo.

Tamaño máximo de TV: pantalla plana de 60".

Página 24

CARGA MAXIMA

Esta unidad ha sido diseñada para soportar la carga máxima anotada. El exceder estos límites puede causar inestabilidad, colapsarse y/o causar serias lesiones.

ADVERTENCIA: aplique la etiqueta de advertencia de TV a su unidad para que siempre tenga los límites de peso y tamaño de TV del modelo.

Tamaño máximo del televisor: pantalla plana de 60".

Página 25

Registre su producto para recibir lo siguiente:

- * Detalles de nuevas tendencias - Vistazo a lo nuevo
- * Encuestas - aloc su voz entre su comunidad
- * Códigos de ofertas y descuentos exclusivos
- * Fácil y rápido servicio de partes de remplace

Para registrar su producto, visite ameriwoodhome.com.

Clasificación de 5 estrellas

Visite el sitio web de su distribuidor local, califique el producto que compró y déjenos sus comentarios.

Nos gustaría enviar un gran "Agradecimiento" a todos nuestros clientes por tomarse el tiempo de ensamblar este producto de Ameriwood Home, y por darnos sus valiosos comentarios.

Gracias

Couverture Avant

CE LIVRET D'INSTRUCTION CONTIENT DES INFORMATIONS **IMPORTANTES** SUR LA SÉCURITÉ. VEUILLEZ LIRE ET GARDER POUR UNE RÉFÉRENCE FUTURE

Ne retournez pas ce produit! Contactez notre équipe de service à la clientèle amicale d'abord pour obtenir de l'aide.

Appelez-nous: 1-800-489-3351 (sans frais) du Lundi au Vendredi de 9h à 17h Heure Centrale

Visitez: www.ameriwoodhome.com

ATTENTION

Le meuble peut basculer et causer des blessures graves ou la mort.

Ancrer le meuble à une planche murale dans le mur (si indiqué).

Ne laissez pas les enfants grimper sur le meuble.

Placez les articles lourds sur les étagères ou dans les tiroirs inférieurs.

Astuces Utiles (page 2)

- Ouvrez votre article dans la zone que vous prévoyez de le garder pour moins de levage lourd
- Identifier, trier et compter les pièces avant d'essayer d'assembler
- Les goujons de compression sont taraudés avec un Marteau
- Les glissières sont marquées d'un R (droit) et d'un L (gauche) pour un bon placement
- Assurez-vous toujours de faire face la pointe situé sur le haut de la Serrure de Came vers le bord extérieur
- Utiliser tous les clous fournis pour le panneau arrière et les répartir également
- Le panneau arrière doit être utilisé pour vous assurer que votre appareil est robuste
- N'utilisez pas de produits chimiques agressifs ou de nettoyeurs abrasifs sur cet appareil
- Ne jamais pousser, tirer, ou faire glisser votre meuble

Avant de Commencer (page 3)

- Lisez attentivement chaque étape et suivez le bon ordre
- Séparez et comptez toutes vos pièces et matériaux
- Donnez-vous suffisamment de place pour l'assemblage
- Avoir les outils suivants: tournevis à tête plate, #2 tournevis Phillips, et Marteau
- Attention: Si vous utilisez une perceuse électrique ou un tournevis électrique pour visser, veillez à ralentir et arrêter lorsque la vis est bien serrée. Le non-respect de cette consigne peut endommager la vis.

Système de Fixation de Came (page 3)

Ce Système de Fixation de Came sera utilisé tout au long de l'assemblage

Identification des matériaux (Page 4-5)

Pas de taille réelle

- (A) HAUT
- (B) BAS
- (C) ÉTAGÈRE
- (D) CÔTÉ GAUCHE
- (E) CÔTÉ DROIT
- (F) CADRE SUPÉRIEUR
- (G) CADRE INFÉRIEUR
- (H) PANNEAU AVANT
- (J) PANNEAU AVANT GAUCHE
- (K) PANNEAU AVANT DROIT
- (L) PANNEAU DE COUP DE PIED
- (F) SUPPORT ARRIÈRE
- (N) PANNEAU DE BASE GAUCHE
- (P) PANNEAU DE BASE DROIT
- (Q) PANNEAU DE BASE CENTRAL
- (R) FOYER

Liste des pièces (Page 6)

Taille réelle

- (1) Boulon à came
- (2) Cheville en bois
- (3) Vis
- (4) Vis
- (5) Vis
- (6) Vis

Liste des pièces (Page 6)

Pas de taille réelle

- (7) Plaque métallique
- (8) Serrure à came
- (9) Colle
- (10) Équerre
- (11) Vis
- (12) Vis
- (13) Ancrage mural
- (14) Pince
- (15) Sangle
- (16) Étiquette d'avertissement

Page 7

- 1.1 Fixez (1) dans (A), (B), (C) et (G) comme illustré.
- 1.2 Insérez (2) dans (C) comme illustré.

Page 8

- 2.1 Fixez (1) dans (D), (E), (F), (L) et (M) comme illustré.
- 2.2 Insérez (2) dans (D), (E), (F), (L) et (M) comme illustré.

Page 9

- 3.1 Fixez (1) dans (N), (P) comme illustré.
- 3.2 Insérez (2) dans (J), (K), (H), (N), (P) et (Q) comme illustré.

Page 10

- 4.1 Fixez (D), (E) dans (C) avec (8) comme illustré.

Page 11

- 5.1 Fixez (F) dans (C), (D) et (E) avec (8) comme illustré.

Page 12

- 6.1 Fixez (H) dans (J), (K) avec (4), (7) comme illustré.

Page 13

- 7.1 Fixez (N), (P) et (Q) dans (M) avec (8) comme illustré.
- 7.2 Fixez (L) dans (N), (P) et (Q) avec (8) comme illustré.

Page 14

- 8.1 Fixez (B) dans (L), (M), (N), (P) et (Q) avec (8) comme illustré.

Page 15

- 9.1 Fixez (H) dans (C) avec (8) comme illustré.

Page 16

10.1 Fixez la base dans (D), (E), (J), (K) avec (6) comme illustré.

Page 17

11.1 Fixez (A) dans (D), (E), (F) avec (8) comme illustré.

Page 18

12.1 Fixez (G) dans (D), (J) avec (3), (8) comme illustré.

12.2 Fixez (G) dans (E), (K) avec (3), (8) comme illustré.

Page 19

13.1 Fixez (R) dans (K), (J) avec (4) comme illustré.

Page 20

14.1 Fixez (10) dans (B) avec (5) comme illustré.

Page 21

AVANT DE BRANCHER L'UNITÉ À UNE PRISE ÉLECTRIQUE MURALE :

Veuillez lire attentivement et suivre les instructions et les avertissements de sécurité dans le « Manuel d'utilisation du foyer pour les propriétaires de foyer » pour faire fonctionner votre foyer correctement.

ATTENTION:

SI LES INFORMATIONS DU MANUEL D'UTILISATION DU FIREPALCE NE SONT PAS SUIVIES, UN CHOC ÉLECTRIQUE OU UN INCENDIE PEUT ENTRAÎNER DES DOMMAGES MATÉRIELS, DES BLESSURES CORPORELLES OU LA MORT.

Page 22

IMPORTANT : CET APPAREIL DOIT ÊTRE FIXÉ AU MUR POUR ÉVITER LE BASCULEMENT. SUIVEZ CES

INSTRUCTIONS POUR INSTALLER LE KIT DE RETENUE DE BASCULEMENT FOURNI AVEC CE PRODUIT :

OPTION 1 : Fixation dans un poteau mural (méthode préférée)

À l'aide d'un détecteur de montants, localisez un montant dans le mur et marquez le mur à travers l'attache (14). Utilisez la vis (12) pour fixer le clip (14) au panneau mural. Utilisez la vis (11) pour fixer le clip (14) au dos de la tablette supérieure. Déplacez le meuble à sa position finale. Faites passer la sangle (15) à travers le clip comme indiqué sur l'illustration, serrez la sangle jusqu'à ce qu'elle soit bien ajustée. Ne pas trop serrer.

OPTION 2 : Fixation dans une cloison sèche

Placez votre unité à l'endroit désiré contre un mur et marquez le mur à travers le clip (14). Percez des trous de 5 mm de diamètre (3/16") dans le panneau mural. Enfoncez l'ancrage mural (13) dans le trou jusqu'à ce qu'il soit aligné. Utilisez la vis (12) pour fixer le clip (14) au panneau mural. Utilisez la vis (11) pour attacher le clip (14) à l'arrière de l'étagère supérieure. Déplacez le meuble dans sa position finale. Enfilez la sangle (15) à travers le clip comme indiqué sur l'illustration, serrez la sangle jusqu'à ce qu'elle soit bien ajustée. Ne PAS trop serrer.

Pour la maçonnerie, le béton ou d'autres matériaux muraux :

Consultez votre quincaillerie locale pour les ancrages appropriés pour fixer solidement le support de sécurité.

Page 23

17.1 Appliquez l'étiquette d'avertissement du téléviseur sur votre appareil afin d'avoir toujours les limites de poids et de taille du téléviseur du modèle.

Taille maximale du téléviseur : écran plat 60".

Page 24

CHARGES MAXIMALES

Ce meuble a été conçu pour supporter les charges maximales indiquées. En excédant ces limites de charge, le meuble pourrait devenir instable, s'effondrer, et/ou causer des blessures graves.

AVERTISSEMENT: Appliquez l'étiquette d'avertissement du téléviseur sur votre appareil afin d'avoir toujours les limites de poids et de taille du téléviseur du modèle.

Taille maximale du téléviseur : écran plat 60".

Page 25

Enregistrez votre produit pour recevoir les éléments suivantes:

- * Détails sur les nouvelles tendances - un aperçu sur les nouveautés
- * Sondages - avoir une voix au sein de notre communauté
- * Offres exclusives et codes promo
- * Service de pièces de rechange rapide et facile

Pour enregistrer votre produit, visitez ameriwoodhome.com.

5 Étoiles

Visitez le site Web de votre détaillant local, évaluez le produit que vous avez acheté et laissez-nous vos commentaires !

Nous tenons à offrir un grand "Merci" à tous nos clients pour avoir pris le temps d'assembler ce produit "Ameriwood Home", et de nous donner vos commentaires précieux.

Merci